

izi-RANGE FURNITURE

be anything.

EN



Furniture

iZi-bar

Body

Skin

Modular iZi-elements

Endless combinations

Accessories

iZi-tables

A minimalist look that's easy to personalize

Displays

iZi-tablet holder

A timeless display

Signage

Lightscreen

Small, medium and large

The 8 beMatrix principles

6

6

8

10

14

16

18

18

24

24

29

29

32



In addition to the versatile beMatrix frame system and its endless options, we now offer iZi-range modular furniture. iZi furniture includes **bars, tables, displays and signage to add that final touch** to your design. The iZi-range boasts the same features as our frame system: it is modular, lightweight, customizable and fast to assemble.



101 Furniture

iZi-bar

Body

The iZi-bar is a stylish and lightweight counter **that can be used as a reception desk, bar or cupboard.** Each iZi-bar comes with shelves, removable doors, a combination lock and adjustable leveling feet. Meet your client's needs by customizing your iZi-bar using hard panel or textile infills.

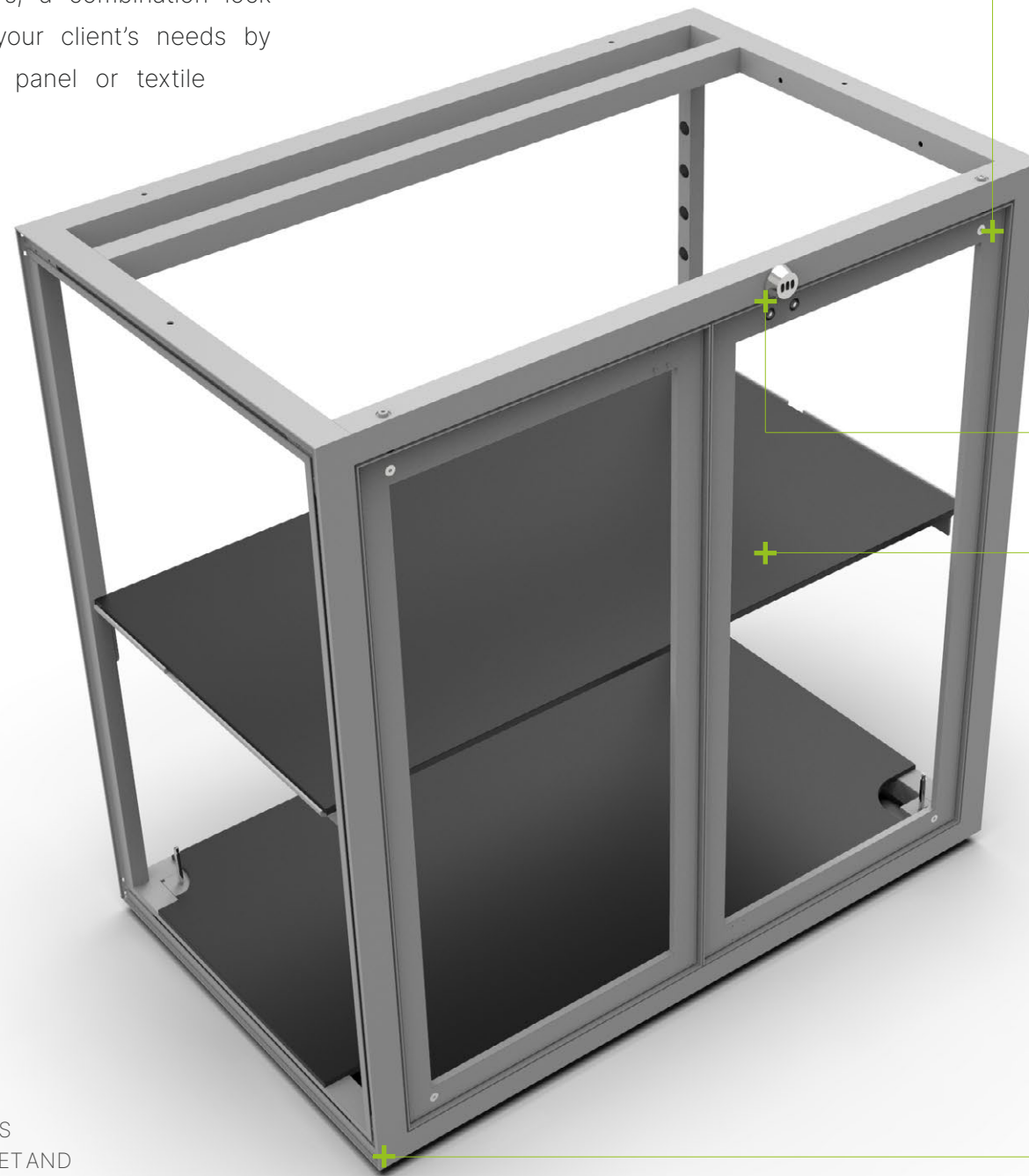

DIMENSIONS: 992 X 620 X 992 MM
STANDARD FINISH: RAL 9006 TEC
AVAILABLE ON DEMAND IN ALL RAL COLORS
ACCESSORIES: 2 SHELVES, ADJUSTABLE FEET AND REMOVABLE DOORS WITH LOCK.

Doors

The **iZi-bar** comes standard with easily removable doors and a combination lock. The combination lock helps insure everything is safely stored and the removable doors mean you can integrate a mini-fridge or other appliances.



Combination lock

A handy combination lock assures everything can be put away safely. No more stressing over losing lock keys.

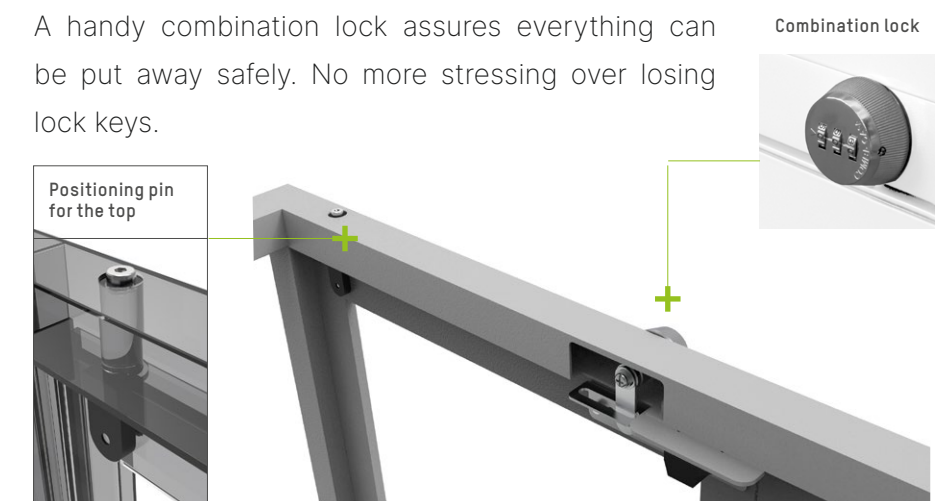

Shelves

The flooring and shelf are part of the standard package. Both are removable and the shelf is adjustable in height.

Feet

The 4 leveling feet, are all individually adjustable letting you stabilize the iZi-bar on uneven floors.

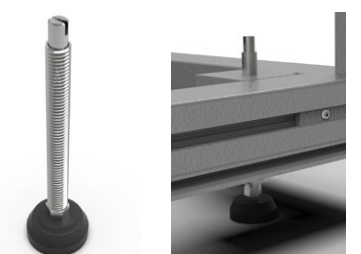

Skin

You can finish your iZi-bar any way you like. Would your customer like to integrate a printed aluminum sandwich panel, a blank PVC panel or rather a personalized textile infill? No problem at all.

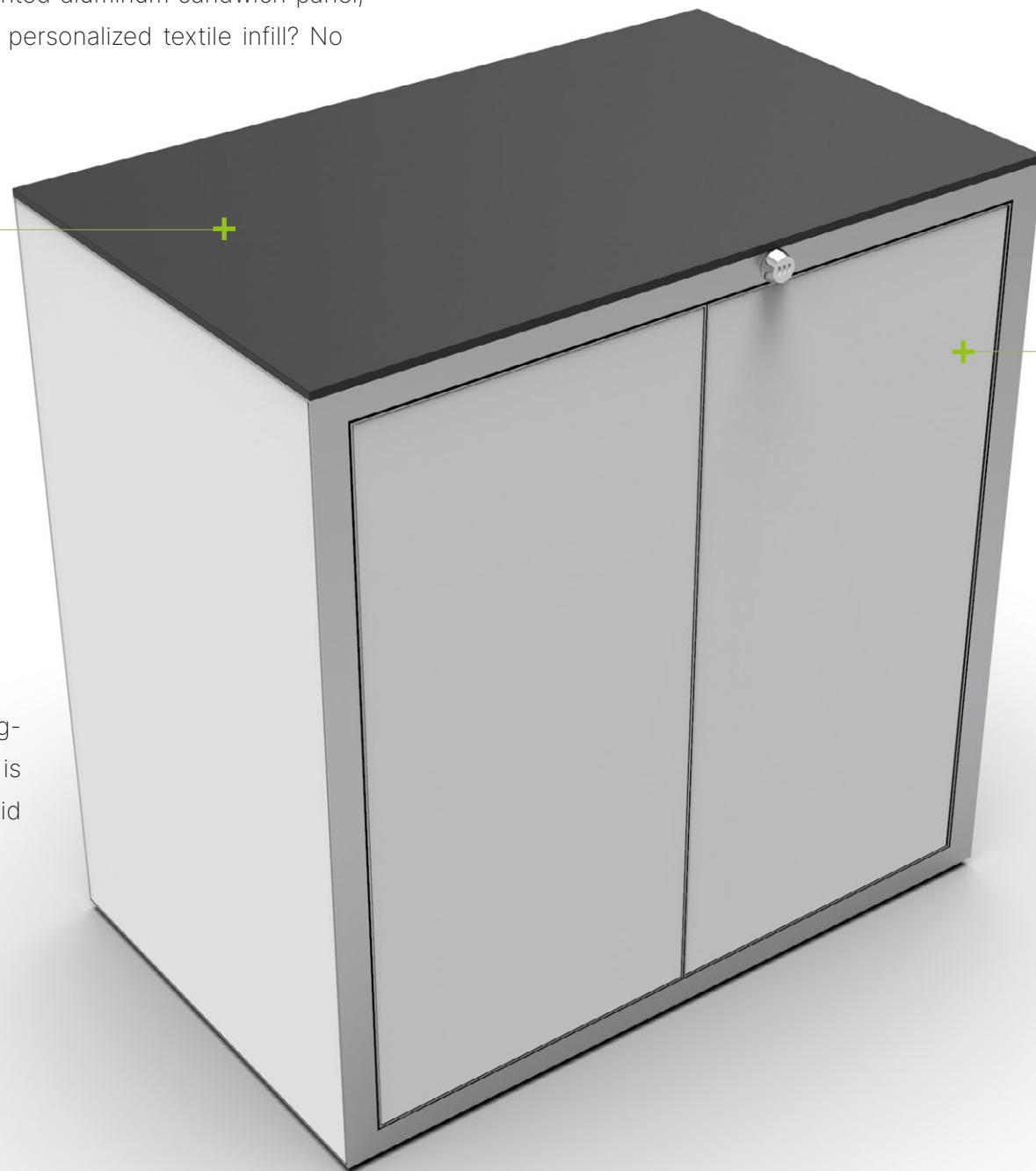

Top

The top can be ordered alongside the iZi-bar "body" and is available as a black/white solid wood panel.

DIMENSIONS: 992 X 620 X 10 MM

Panel

Want an an aluminum infill or PVC panel with a printed design? Prefer to leave it blank? The choice is yours.

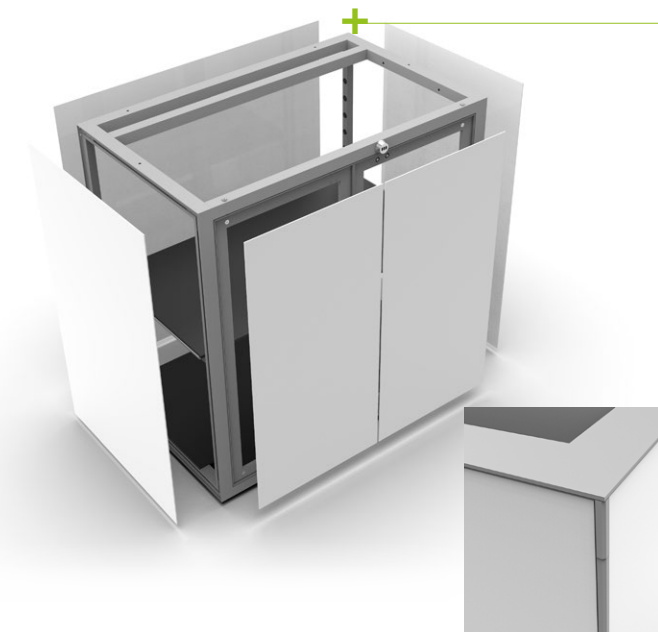

Thanks to the miter joint on both front corners of the iZi bar, the sides of the panels remain invisible.

Seamless textile

Cover 3 sides of the iZi bar with a single piece of textile infill for a seamless result. Want to combine iZi bars? This principle can also be applied to several iZi-bars that are joined together.

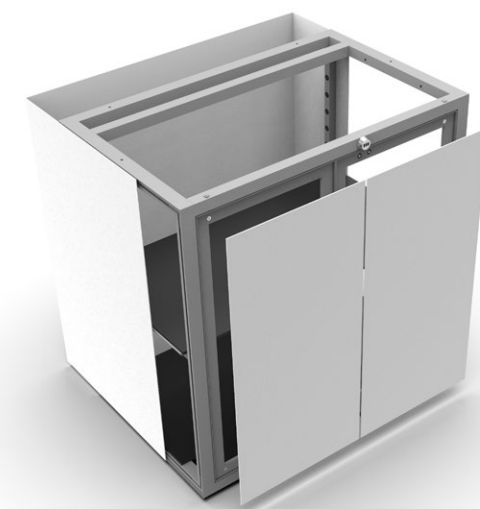

Modular iZi-elements

The iZi-range is based on the same DNA as the beMatrix frame system. Modularity and flexibility are pivotal. **Add additional modular elements to change the iZi-bar into different structures** in no time at all.

Barfly

Add one or two **barfly** elements to the iZi-bar for a dynamic look. A nice finishing touch without a lot of effort!

DIMENSIONS: 992 X 620 - R 496

STANDARD FINISH: RAL 9006 TEC

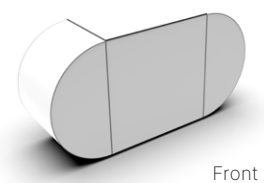

Front

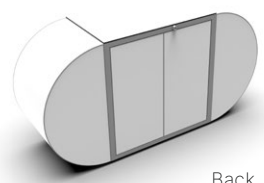

Back

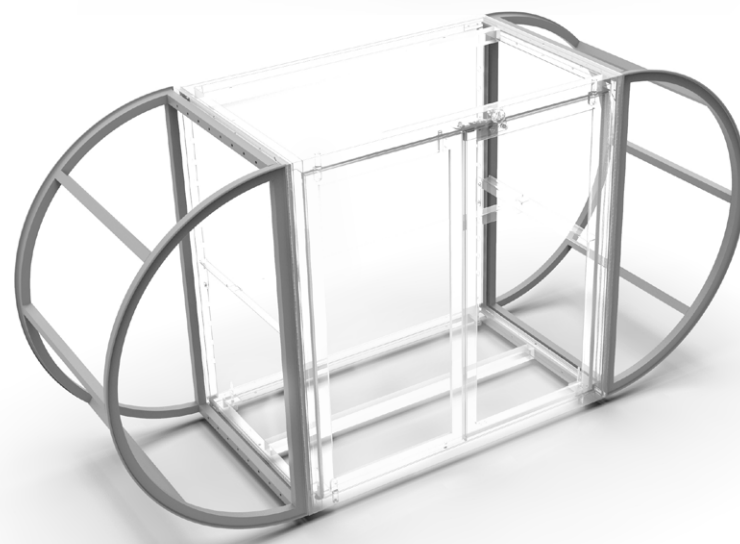

iZi-bar Corner

Add an **iZi-bar Corner** to elongate your bar or create that perfect corner look!

DIMENSIONS: 620 X 620 X 992 MM

STANDARD FINISH: RAL 9006 TEC

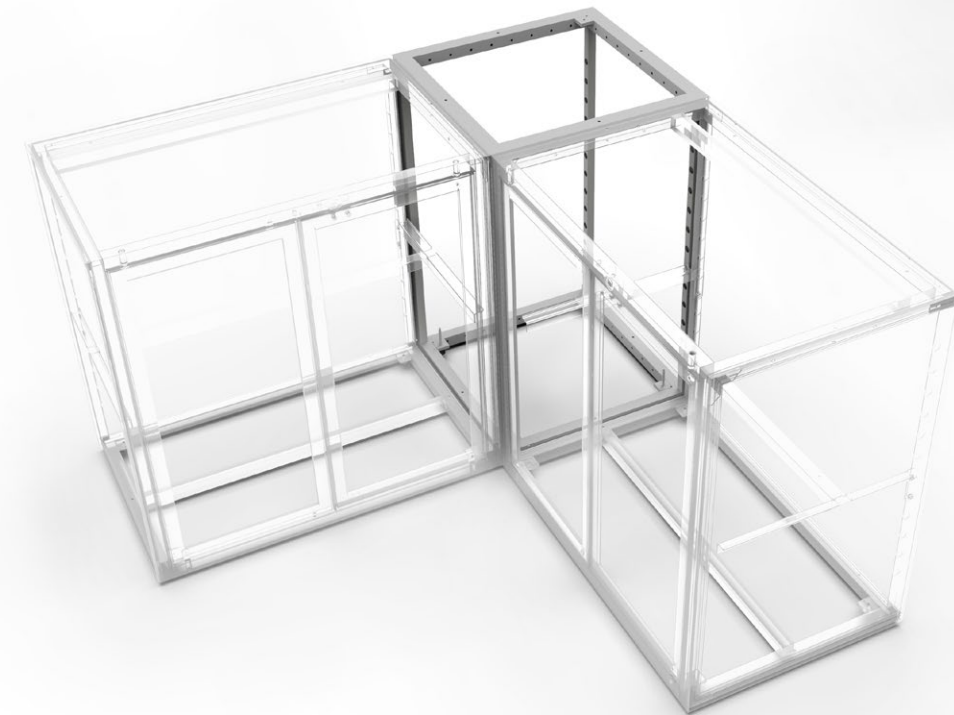

The iZi-bar Corner can also be used as a stand-alone display.

iZi-bar Elevation

Why not turn the iZi-bar into an out-of-view piece of furniture? Thanks to the **iZi-bar Elevation**, now you can! The iZi bar elevation is a handy add-on that is also available in a corner option to match the iZi-bar Corner. What a great way to give the look of iZi-bar a total overhaul!

DIMENSIONS ELEVATION: 248 X 992 MM

DIMENSIONS CORNER ELEVATION: 620 X 620 X 248 MM

STANDARD FINISH: RAL 9006 TEC

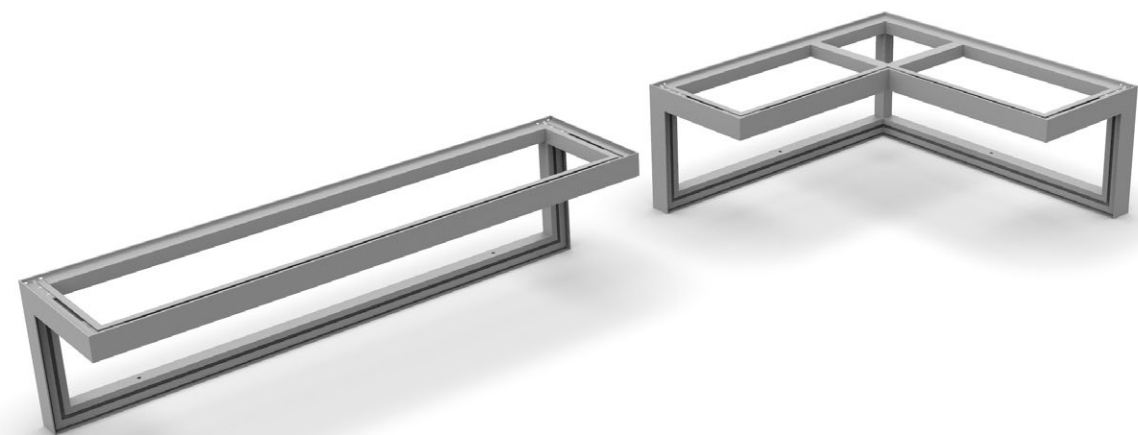

Endless combinations

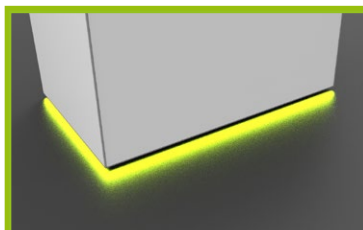
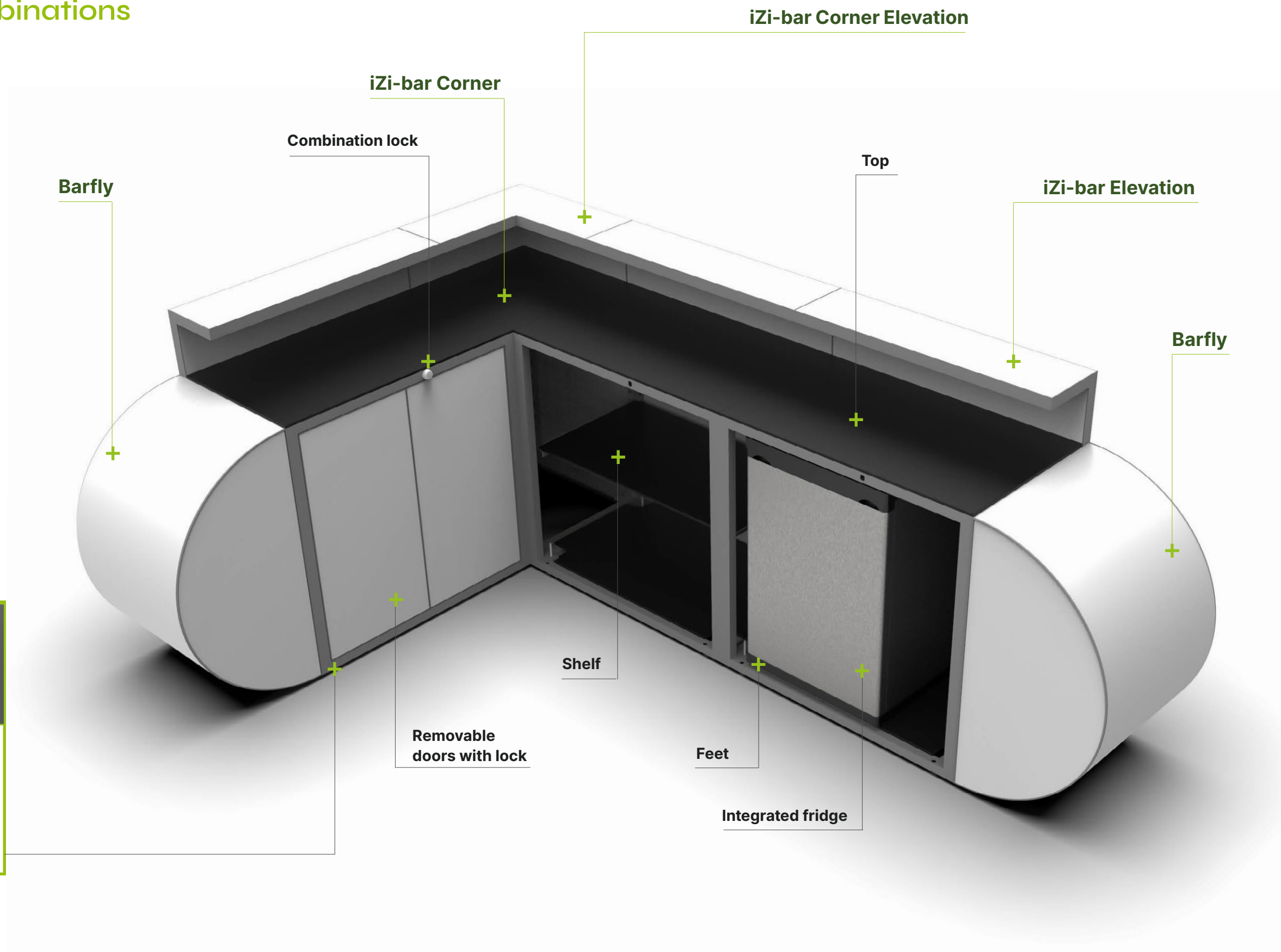

Tip: why not install an indirect light strip around the bar for that floating effect

Accessories

f31 - b62 connector

This connector allows you to easily connect your b62 frames to the iZi-bar opening up more options to create totally different kinds of furniture or displays.

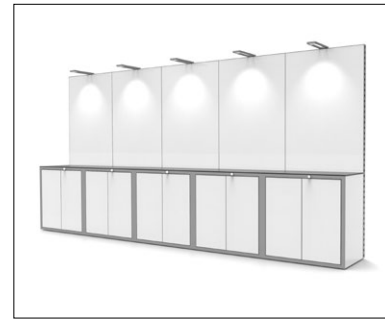
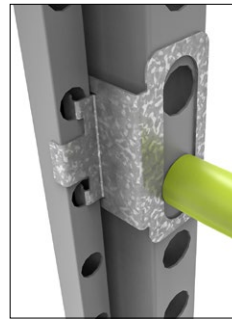

f31 - b42 connector

The f31-b42 connector enables you to easily connect any special shape in the b42 range to the iZi-bar.

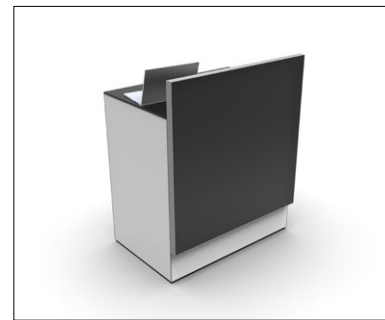
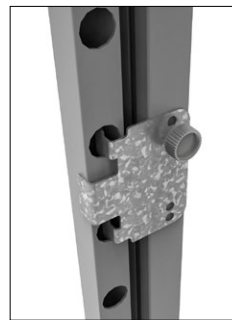

Universal f31 connector

Using our universal connectors, you can add several elements to the iZi-bar, such as a lightbox or bar element. A fantastic way to customize your bar!



iZi-range connector

This connector can be used to connect multiple iZi elements (iZi-bars, iZi-bar elements) simply and easily.

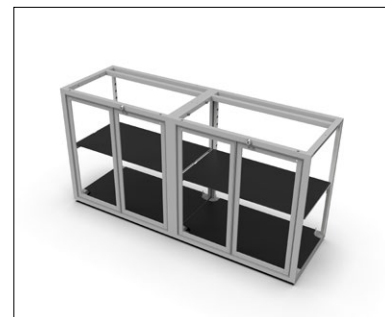
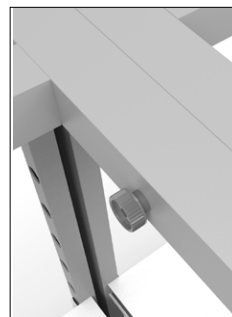

PRODUCT	APPLICATION	ID	DESCRIPTION	DIMENSIONS	FINISH
		420 003 0992	iZi-bar	992 x 620 x 992 MM	RAL 9006 TEC Customizable RAL color
		420 004 01	iZi-bar Corner	620 x 620 x 992 MM	RAL 9006 TEC Customizable RAL color
		420 004 02	iZi-bar Elevation	L 992 MM	RAL 9006 TEC Customizable RAL color
		420 004 03	iZi-bar Corner Elevation	248 X 620 X 248 MM	RAL 9006 TEC Customizable RAL color
		420 004 04	Barfly module	992 X 620 MM R 0496	RAL 9006 TEC Customizable RAL color
		420 3703 001	f31 - b62® connector Galva		kit with 4 connectors
		420 3703 002	f31 - b42 connector Galva		kit with 4 connectors
		420 3703 003	f31 Universal connector Galva		kit with 4 connectors
		420 7000 001	iZi-range connector set		kit with 4 connectors
		420 308 001 01	HPL panel 10MM for iZi-bar		Matte White
		420 308 001 02	HPL panel 10MM for iZi-bar		Matte Black
		420 308 001 03	HPL panel 10MM for iZi-bar corner		Matte White
		420 308 001 04	HPL panel 10MM for iZi-bar corner		Matte Black

iZi-tables

A minimalist look that's easy to personalize

Apart from the iZi-bar, beMatrix also offers a range of **iZi-tables: ready-made tables or columns that can be covered with all kinds of infills** to match the set-up or function of your design.

iZi-wall table

DIMENSIONS: 620 X 620 X 1054 MM

STANDARD FINISH: RAL 9006 TEC

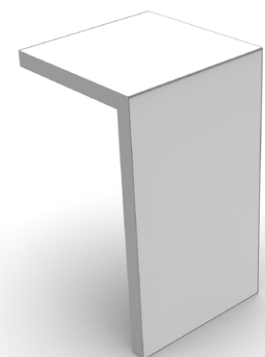

iZi-high table

DIMENSIONS: 1054 X 620 X 1488 MM

STANDARD FINISH: RAL 9006 TEC

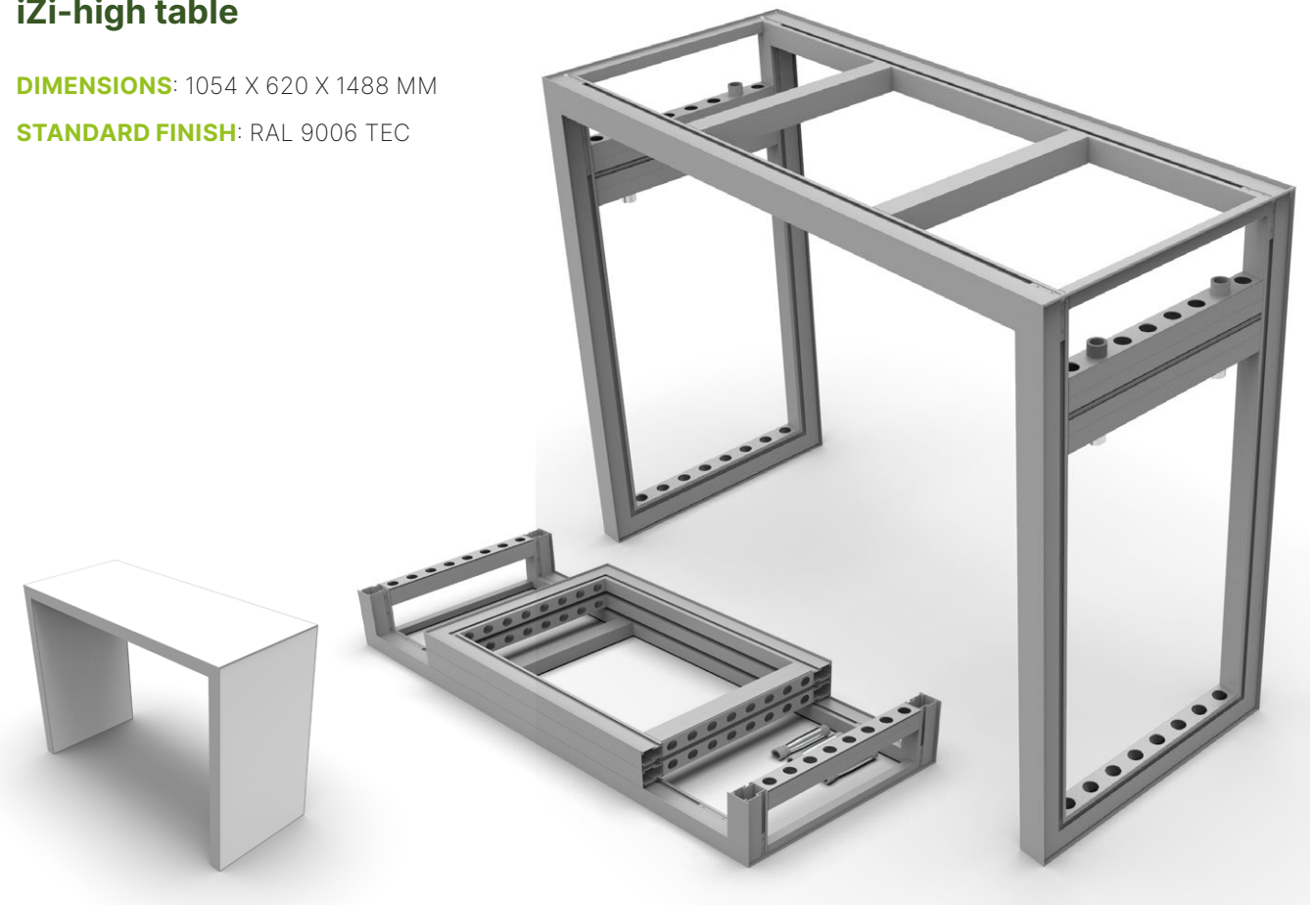







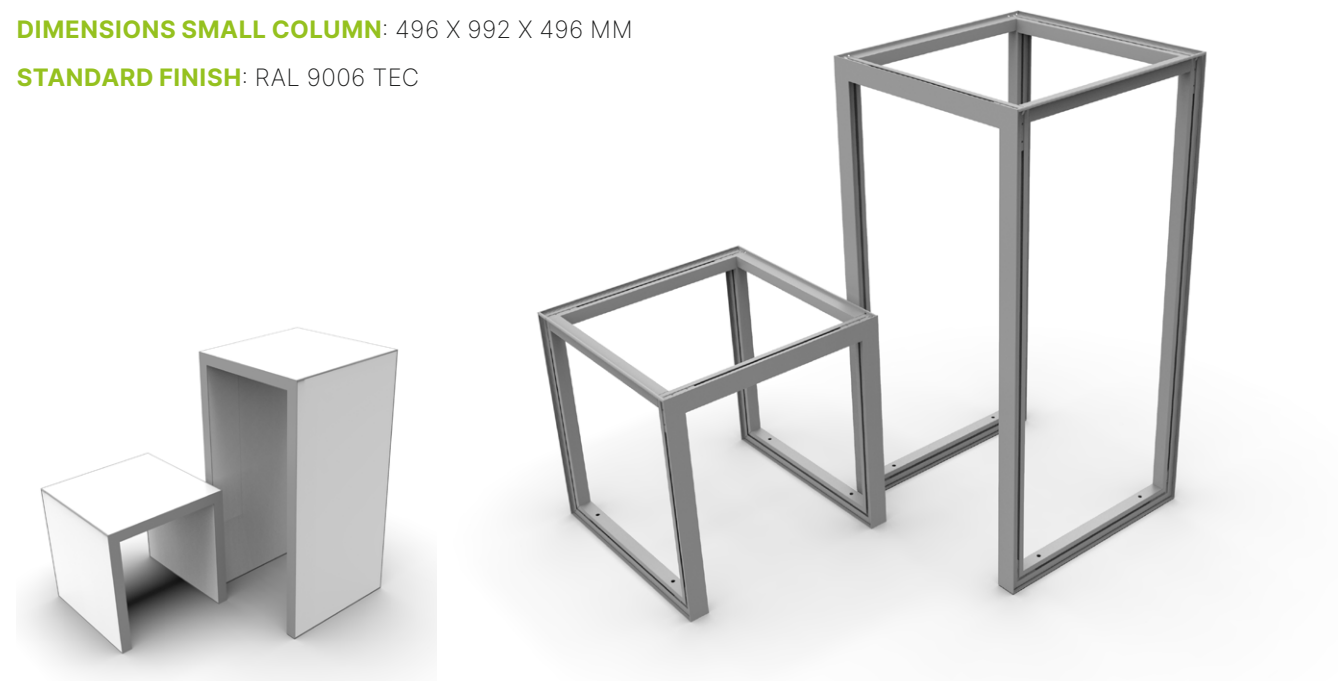

iZi-column

DIMENSIONS SMALL COLUMN: 496 X 496 X 496 MM

DIMENSIONS SMALL COLUMN: 496 X 992 X 496 MM

STANDARD FINISH: RAL 9006 TEC



PRODUCT	APPLICATION	ID	DESCRIPTION	DIMENSIONS	FINISH
		422 001 0620	iZi-wall table	620 x 620 x 1054 MM	RAL 9006 TEC Customizable RAL color
		422 002 1984	iZi-high table	1054 x 620 x 1488 MM	RAL 9006 TEC Customizable RAL color
		423 001 01	iZi-column Small	496 x 496 x 496 MM	RAL 9006 TEC Customizable RAL color
		423 001 02	iZi-column Large	496 X 992 X 496 MM	RAL 9006 TEC Customizable RAL color

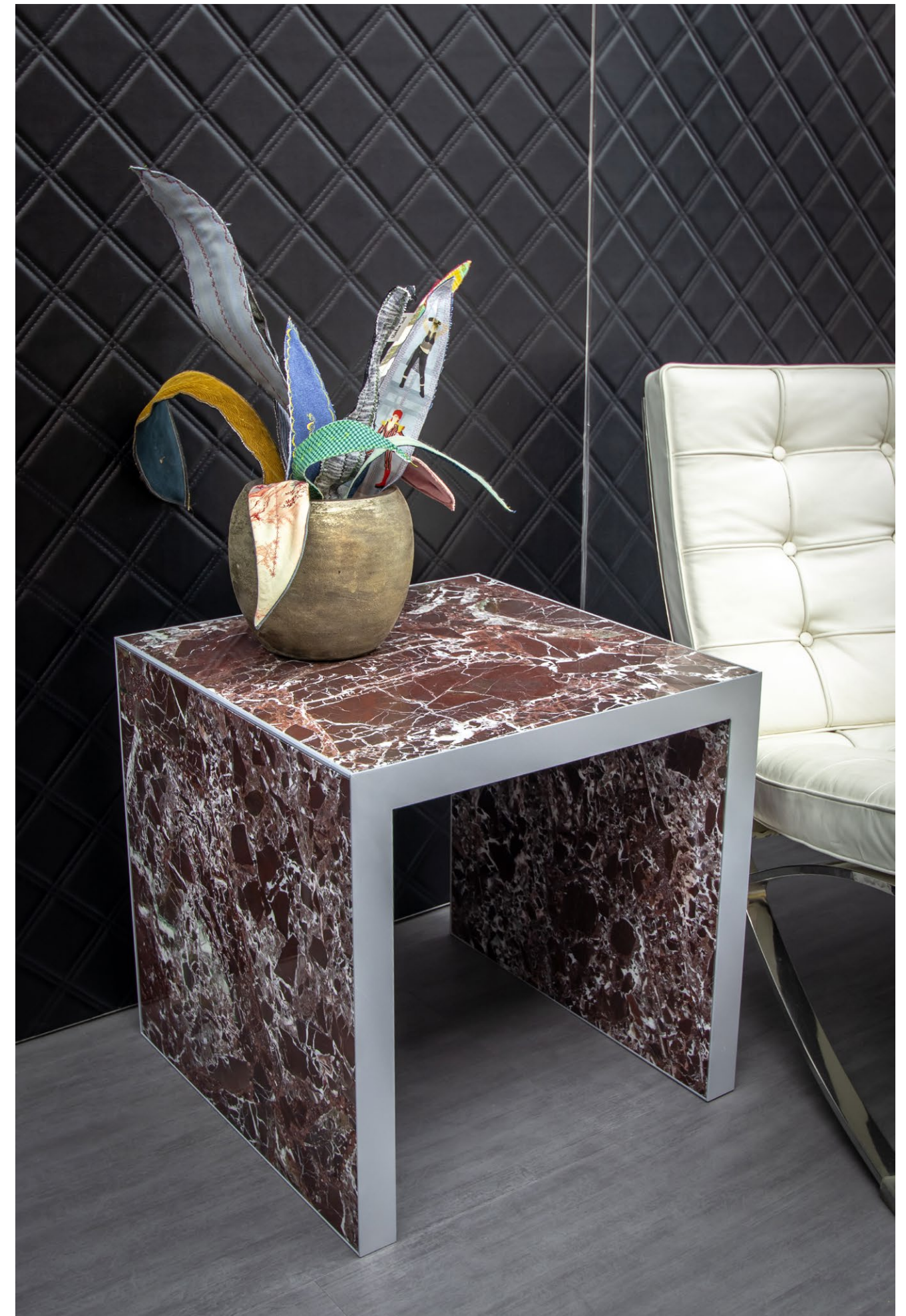



02

Displays

iZi-tablet holder

A timeless display

Not only does the iZi-tablet holder stand out because of its **minimalist look, it also provides space for cables and security accessories thanks to its savvy design.** The back is covered by a foam protector that keeps your tablet firmly in place. The iZi-tablet holder immediately adds allure to any design.

DIMENSIONS: 240 X 1155 X 362 MM

STANDARD FINISH: RAL 9006 TEC

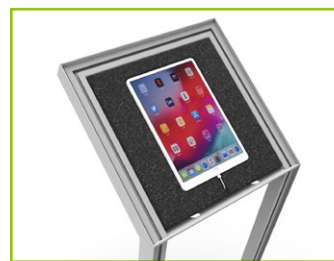

Foam protection

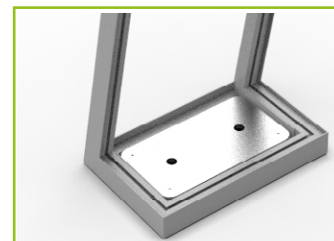

Tip: The plate with screw holes at the base of the display makes it possible to secure the iZi-tablet holder onto a raised floor.



Infill

Give your iZi-tablet holder any look you'd like. Does your client need printed dibond or a plain forex panel? Anything is possible!

PRODUCT	APPLICATION	ID	DESCRIPTION	DIMENSIONS	FINISH
		425 001 01	iZi-tablet holder	240 x 1155 x 362 MM	RAL 9006 TEC
					Customizable RAL color

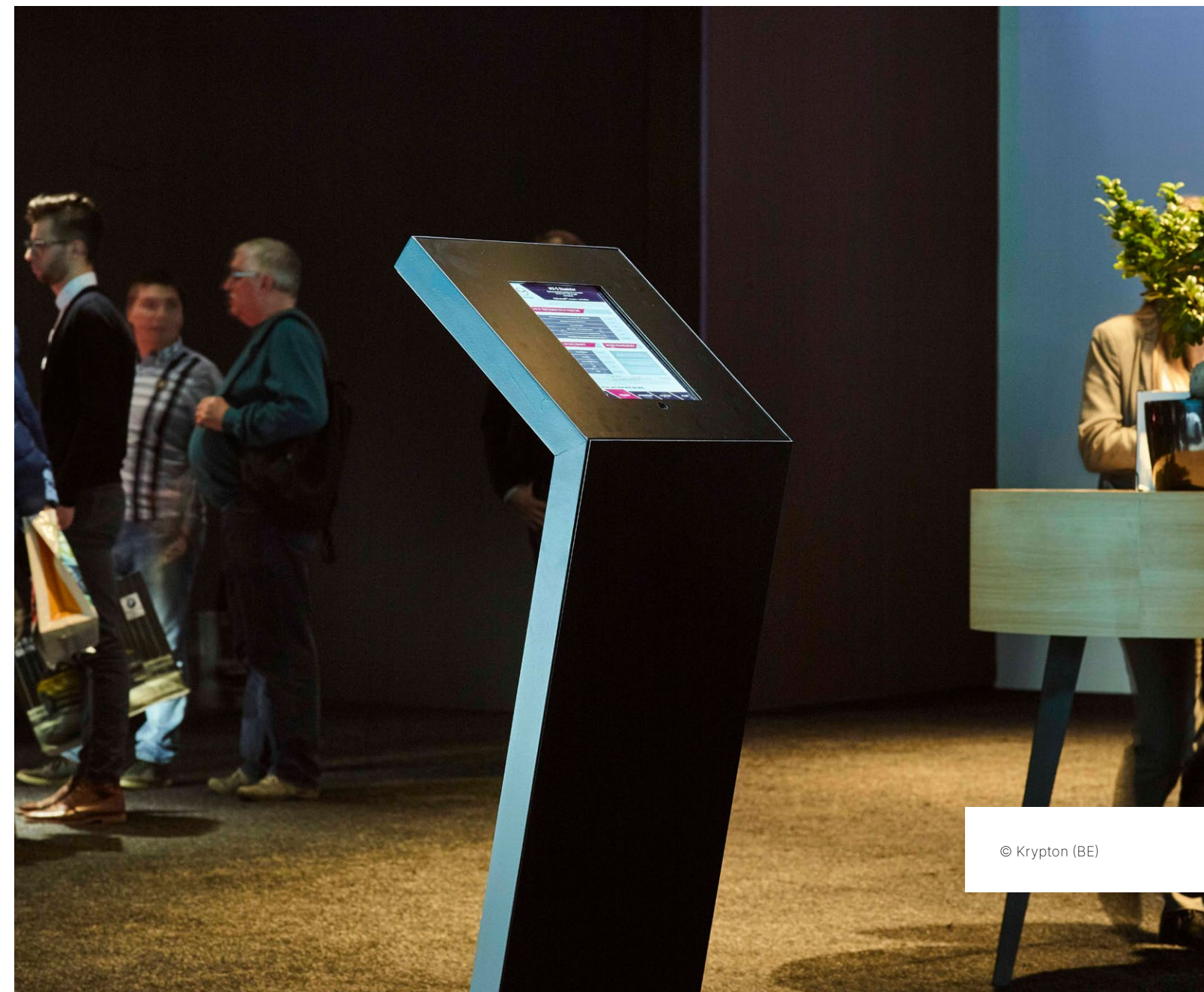

GRAMMA

LES PRODUITS FRAIS DE LIDL POUR CEUX QUI DUIT LEANT

DE VERS



THE LAST KILOMETER - PHILIPPE GILBERT

2005

HET JAAR VAN TOMS DOORBRAAK



"Tommeke, Tommeke, Tommeke, wat doe je nu?"

BEIGISCHE TV COMMENTATOREN

De klassiekkouers wachten op een nieuwe heren. Het was Tom Boonen die als onbetwiste koning naar voren kwam. Hij nam een sensationele dubbeldrievoud naar in De Bunde en Paris-Roubaix. Dat was niet eens de kern op de toern, maar het opentafel van naar wat later bleek een van de beste seizoenen die een renner meemakke in de recente geschiedenis. Nadat hij de Noordelijke klassiekers getemd had, won Tommeke twee ritjes in de Tour. De frustratie van zijn opvoer in de Tour werd hij ook kap stond in het puntenklassement zette hij om in een geweldige zorge op het Wereldkampioenschap in Madrid. Hij bracke de Belgische commentatoren en de hele natie in verwondering.

"Tommeke, Tommeke, Tommeke, wat doe je nu?"

BEIGIAN TV COMMENTATORS

The cobbled Classics were waiting for their new ruler and it was Tom Boonen who came out of them as the undisputed king, after carving out a sensational De Bunde - Paris-Roubaix double which wasn't even being rung on the cake that year. But the real prize, if what turned out to be one of the finest seasons a rider has had in recent history. After taking the tough northern classics, Tommeke conquered two Tour de France stages and later found the frustration of having to abandon the race through injury while leading the points competition into an outstanding victory in the World Championships in Madrid, sending the Belgian commentators and an entire nation into raptures.

2013

TOEGESCHRIJFT HISTORIE



"We've come under a lot of criticism this year as a team in the sports and industry press. We arrived at the start with the intention of winning every event and we haven't lost any sleep about what we think is quite a strong way to finish."

"Mijn passie voor de wielersport ontstond nadat ik kleine jongen Eddy Merckx op televisie zag. Hij was een gekkenman galactisch sterk in de toernamen van de sport en deze ploeg."

HET F

2006

GLORIE OP DE CHAMPS-ÉLYSÉES



"Grote kampioenen in je ploeg hebben die voor dezelfde doelen gaan is een luxe probleem."

PATRICK JEREVERS

Nadat hij al enkele jaren geprepareerd had om het puntenklassement in de Tour te winnen, sloegde Tom Boonen in 2006 een veldje in om het groene trui mee te nemen naar België. Daarnaast maakte hij een hattrick in de klassiekkouers. In de maand september won Patrick Boonen opnieuw het hoogste schouder bij het Wereldkampioenschap in Stuttgart. De regerendste bleef maar achter in de Tour. De regerendste bleef maar achter in de Tour.

"Having great champions that go for the same objectives is a luxury problem."

PATRICK JEREVERS

After several years of being in with the Tour de France points classification, Tom Boonen finally managed to win the green jersey which Belgium was waiting for nearly half a century. In addition to that, he also won a hattrick of cobbled classics victories in the month of September. Boonen repeated his success in the World Championships. He took the top spot in the podium of the Tour de France and the highest overall position in the 2006 winners of the Tour de France.

"Winne bel H

PATR

TOEN



Alles begon dit jaar toen Patrick Boonen een nieuwe ploeg voor de Tour de France maakte. De ploeg deelde zijn visie op de wereld en had de ambitie om een van de beste ploegen te worden. Met 2006 begon de Tour de France met Johan Museeuw, Frank Berti, Richard Virenque en de jonge veelbelovende Tom Boonen. Het was niet lang voordat Quick-Step de ploeg van de mens was. De ploeg begon met de laatste maanden van februari en met de laatste maanden van februari won Museeuw de Tour de France dankzij een fantastische ploeg met drie andere prestigieuze klassiekers: Milano-Sanremo, Clásica de San Sebastián en de Cyclassics Hamburg. In de Tour de France mocht in deze koers een ploeg met de ploeg dragen en reed met de ploeg dragen en reed met de ploeg dragen. Aan het einde van de Tour de France ploeg meer dan 20 keer g

signage





Lightscreen

Small, medium and large

There is no end to the creative ways in which you can use our lightboxes. From a perfectly aligned lightbox and frame for a flawless minimalist look, to a unique combination of lightboxes in all shapes and sizes, for a fabulous eye-catching 3D effect. **Easily mount the sideLED lightboxes onto the beMatrix frame system** using large holes, or just use them as a free-standing item. The lightscreens are available in stock, but custom options are available on request.

PRODUCT	APPLICATION	ID	DESCRIPTION	DIMENSIONS	FINISH
		431 0496 2480	Lightscreen Small	496 × 2480 MM	RAL 9006 TEC Customizable RAL color
		431 0992 2480	Lightscreen Medium	992 × 2480 MM	RAL 9006 TEC Customizable RAL color
		431 1984 2480	Lightscreen Large	1984 × 2480 MM	RAL 9006 TEC Customizable RAL color



BAR
© Optimum Concept
& Krypton (BE)



BAR
© Moodunit (BE)



DESK
© Choup's (Silver
Partners) (BE)



DISPLAYS
© Quick-Step (BE)



IPAD DISPLAY
© Krypton (BE)



CABINETS
© G9 Stockholm (SE)



DESK
© DesyTech (FR)

The 8 beMatrix principles



Quality guaranteed

All beMatrix frames are manufactured in-house, so we are in control of every step in the production process. Continuous optimization and innovation initiatives ensure the system always meets the market's demands.



Finishing options

The beMatrix system comes with a large range of tools and accessories to help you finish your booth exactly the way you envisioned. With hard panel or textile infills, you can even hide the entire frame system so it becomes invisible to the eye.

Freedom to design

beMatrix combines the benefits of a modular system with the possibilities of a custom solution. Almost any shape, contour or design is conceivable and can easily be created. One single frame allows you to create many different kinds of design concepts.



Lightweight

The aluminum frame system is lightweight making it ergonomic and eco-friendly. This lightweight design makes it easy for the exhibit or event builder to move frames and keep CO2 emissions low during shipping or transport.



Fast

Assembly and disassembly of the beMatrix system is quick and easy. Its lightweight, simplicity and tool free assembly save loads of time, leaving you free to focus on the finishing details of your booth.

Long life cycle

The system is extremely sturdy, making it endlessly reusable. Wear and tear won't shorten its lifespan, since the frame is not visible to the eye once the entire design is set up and infills are added.

Ecologically sustainable

Because of its low weight, long life cycle and modular character, the beMatrix frame system is the most eco-friendly system on the market today. Moreover, it is made out of untreated aluminum, making it 100% recyclable and reusable without any loss in quality.

International network

The bePartner network brings together real ambassadors of the beMatrix frame system, each with their own expertise. bePartners are vetted annually giving you peace of mind.





be strong  **be stylish**
be anything.

Come say hi

beMatrix USA
4476 Park Drive
Norcross, GA 30093

get in touch

770 225 0552
info@beMatrix.us

or boost your inspiration

www.beMatrix.us
socials @beMatrix
