

# izi-RANGE FURNITURE

be anything.

EN





# Furniture

## iZi-bar

Body

Skin

Modular iZi-elements

Endless combinations

Accessories

## iZi-tables

Minimalist look and easy to personalise

# Displays

## iZi-tablet holder

Timeless display

# Signage

## Boxscreen

Mini

## Lightscreen

Small, medium and large

**The 8 beMatrix principles**

**bePartners at your service**

**Global Rental Network: short- and long-term**

**6**

6

8

10

14

16

**18**

18

**24**

24

**28**

28

**31**

31

**34**

**36**

**38**



In addition to the versatile beMatrix frame system and its endless options, we now also offer the iZi-range: **modular furniture such as bars, tables, displays and signage to add that final touch** to your stand, conference or retail booth. The iZi furniture boasts the same features as our frame system: it is modular, ideal for temporary constructions, customisable with plain or printed panels or textiles, very fast to assemble ...





# 01 Furniture



# iZi-bar

## Body

The iZi-bar is a **versatile reception desk that can be just used to that particular purpose**, but just as well serve as a bar or cupboard. Its very stylish design is the result of using lightweight aluminium profiles. The iZi-bar contains 2 shelves, removable doors with lock and feet that can be adjusted in height. You can choose from panels or textile infills, so it is ever so easy and quick to customise the iZi-bar, exactly to your clients' liking...

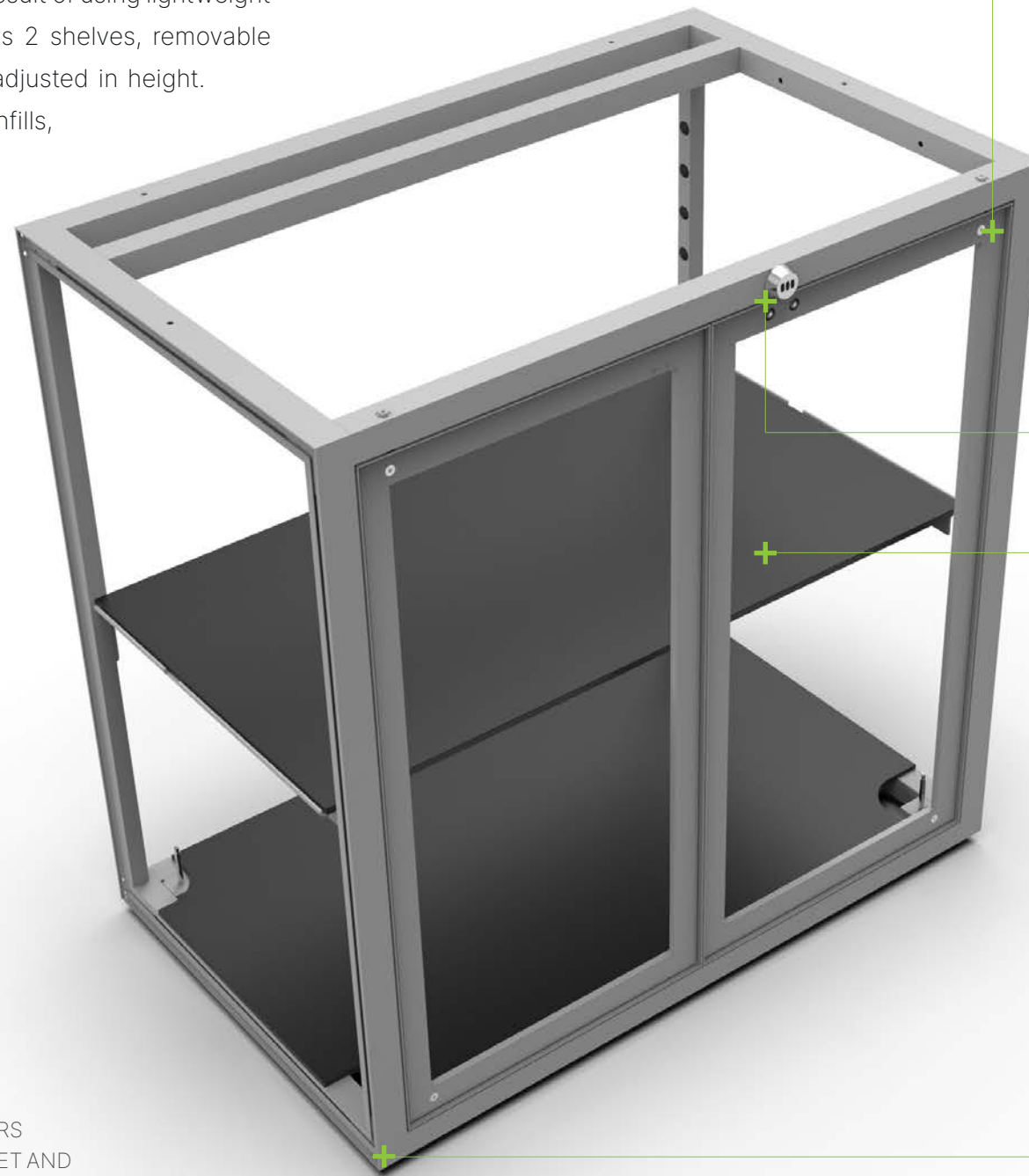

**DIMENSIONS:** 992 X 620 X 992 MM  
**STANDARD FINISH:** RAL 9006 TEC  
AVAILABLE ON DEMAND IN ALL RAL COLOURS  
**ACCESSORIES:** 2 SHELVES, ADJUSTABLE FEET AND REMOVABLE DOORS WITH LOCK.

## Doors

The **iZi-bar** comes standard with simply removable doors that have a lock, making sure everything is safely stored. By not using the doors, you can integrate a fridge or another kind of appliance in the bar.



## Combination lock

A handy combination lock assures everything can be put away safely. No more stress about losing keys anymore!

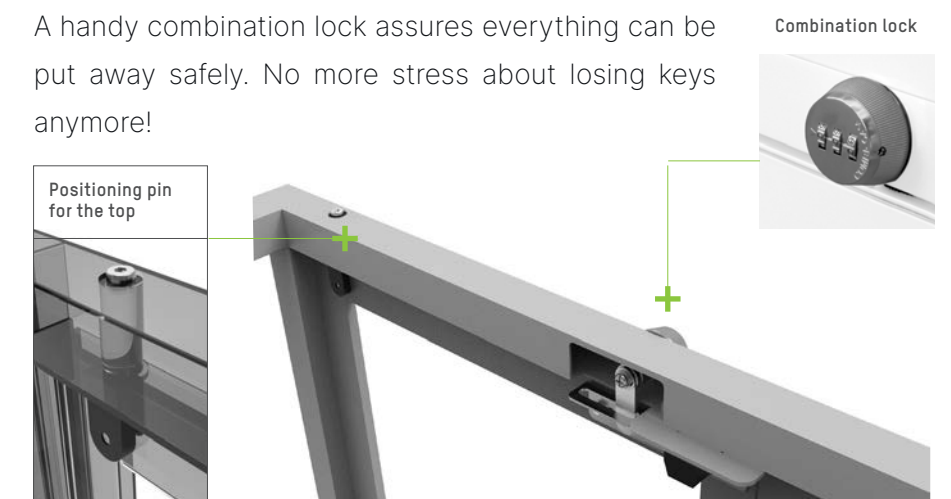

## Shelves

The flooring and 1 shelf are a part of the standard package. Both are removable and the shelf is adjustable in height.

## Feet

The 4 feet, all individually adjustable, are ideal to stabilize the iZi-bar on uneven floors. When the feet are fully integrated, the actual base of the iZi-bar itself rests on the floor.

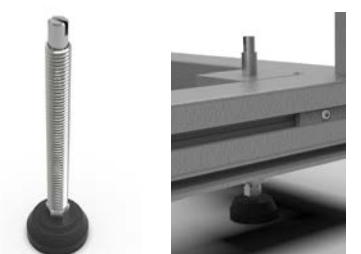

## Skin

**You can finish your iZi-bar any way you like.** Would your customer like to integrate a printed aluminium sandwich panel, a blank PVC panel or rather a personalised textile infill? No problem at all.

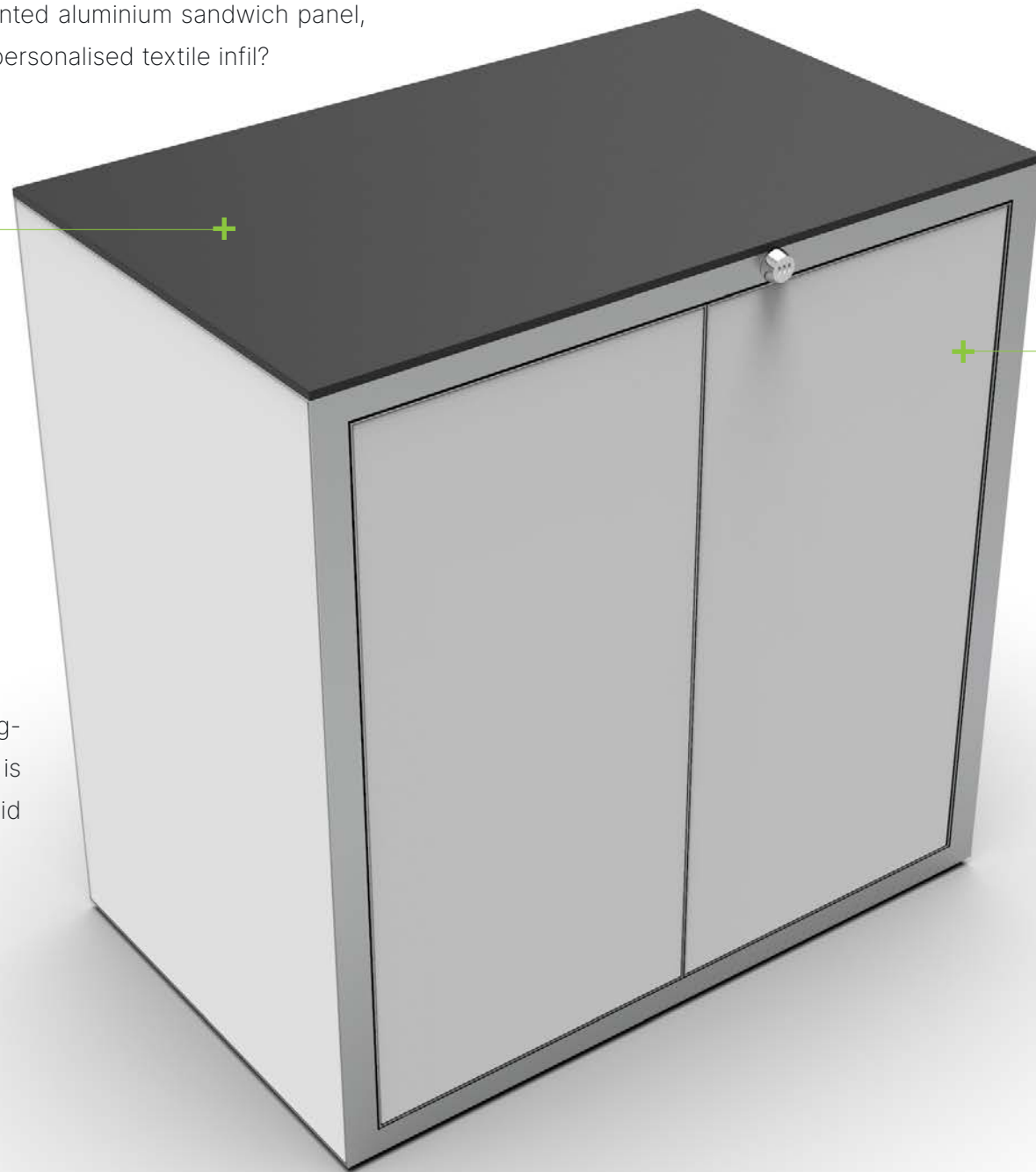

### Top

The top can be ordered alongside the iZi-bar 'body' and is available as a black/white solid wood panel.

**DIMENSIONS:** 992 X 620 X 10 MM

### Panel

Do you prefer an aluminium sandwich panel or rather a PVC panel, with or without print? The choice is yours.

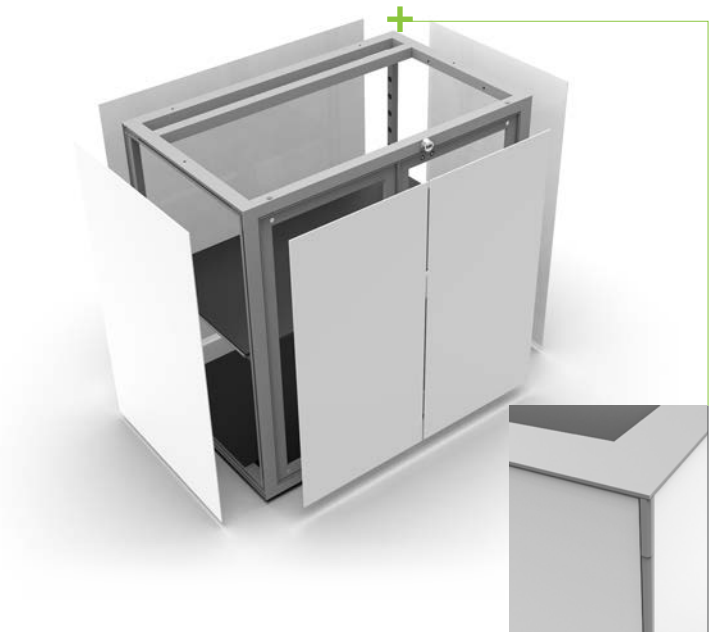

Thanks to the mitre joint on both front corners, the sides of the panels remain invisible.

### Seamless textile

For a seamless result, cover the 3 sides with 1 piece of textile. This principle can also be applied to several iZi-bars that are joined together.



## Modular iZi-elements

The iZi-range is based on the same DNA as the beMatrix frame system. Modularity and flexibility are pivotal. **You can change the iZi-bar in no time at all into a different bar structure**, simply by adding an additional modular element.

### Barfly

Add one or two **barfly** elements to the iZi-bar for a dynamic look. A real transformation, hardly any effort.

**DIMENSIONS:** 992 X 620 - R 496

**STANDARD FINISH:** RAL 9006 TEC

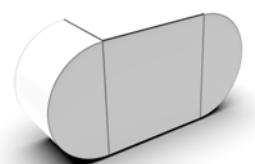
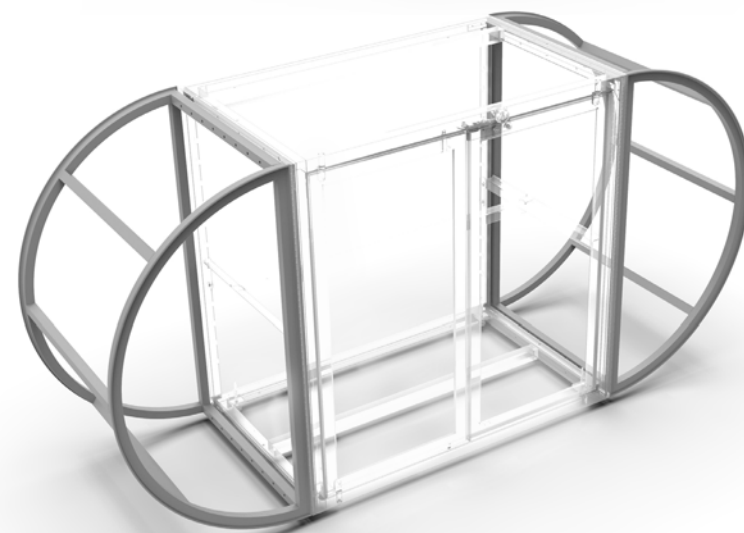

Front

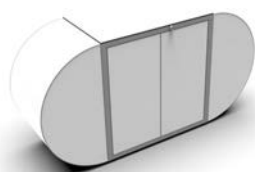

Back

### iZi-bar Corner

The **iZi-bar Corner** is a great solution to create that perfect corner, even elongating your bar. A perfect fit!

**DIMENSIONS:** 620 X 620 X 992 MM

**STANDARD FINISH:** RAL 9006 TEC

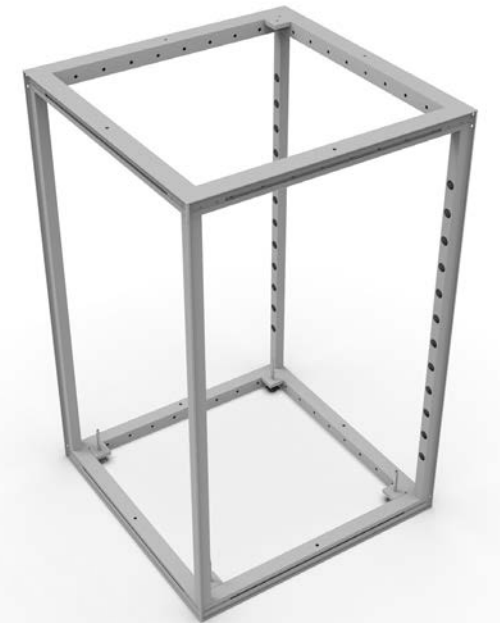

The iZi-bar Corner can be perfectly used as a stand-alone display.



## iZi-bar Elevation

Why not turn the iZi-bar into a free of view piece of furniture, thanks to the **iZi-bar Elevation**. A handy add-on that is also available in a corner set-up to match the iZi-bar Corner. What a handy way to give the iZi-bar a total overhaul!

**DIMENSIONS ELEVATION:** 248 X 992 MM

**DIMENSIONS CORNER ELEVATION:** 620 X 620 X 248 MM

**STANDARD FINISH:** RAL 9006 TEC

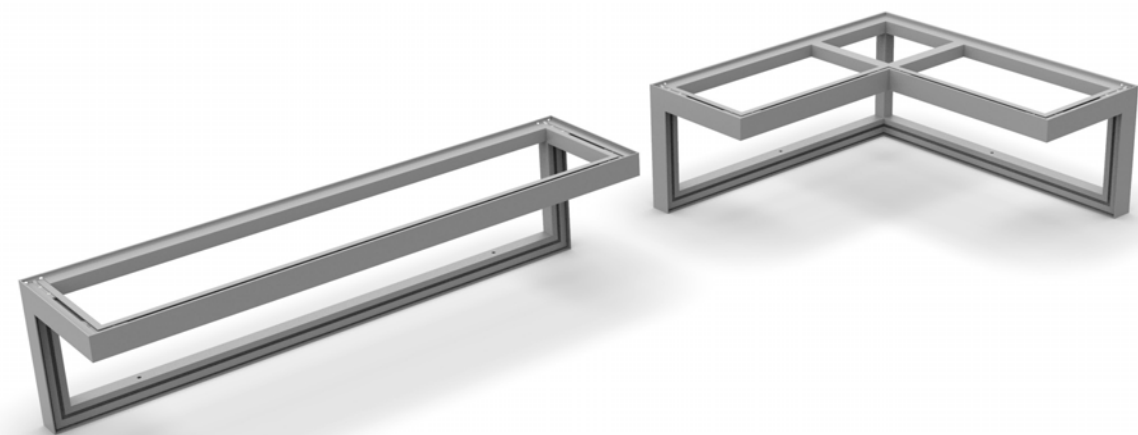

## Endless combinations

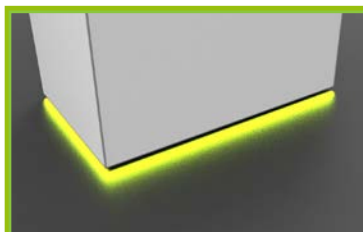
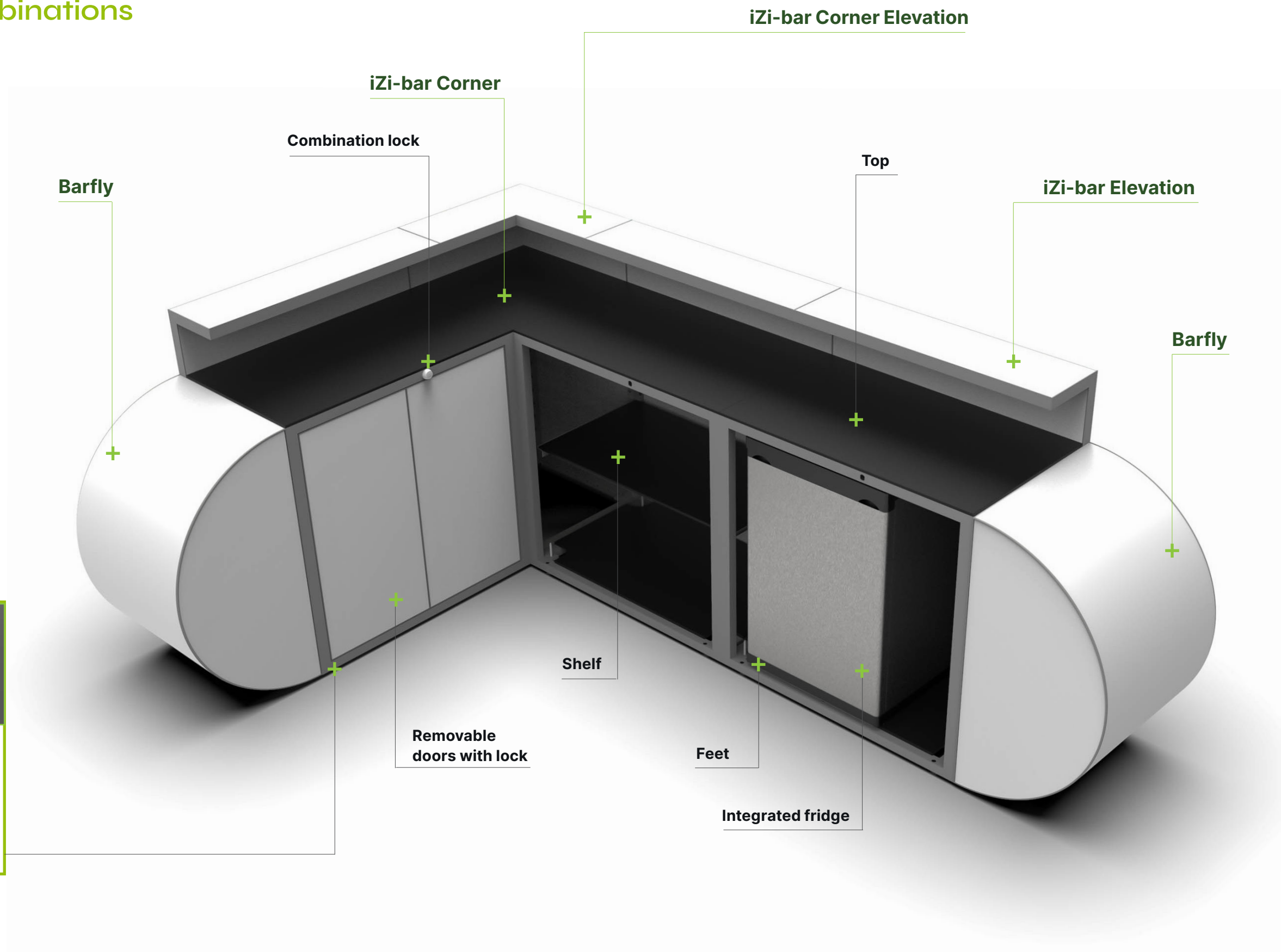

**Tip:** why not install an indirect light strip around the bar for that floating effect.



## Accessories

### f31 - b62 connector

This connector allows you to easily connect the b62' frames to the iZi-bar, opening up all kinds of options to create a totally different kind of furniture or display.

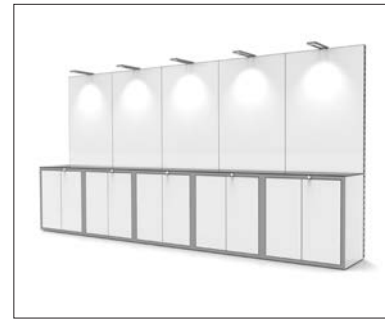
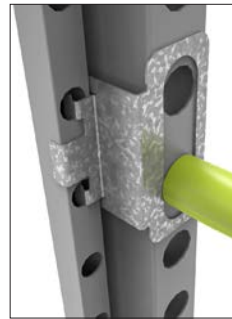

### f31 - b42 connector

The f31-b42 connector enables you to easily connect any special shape in b42 to the iZi-bar.

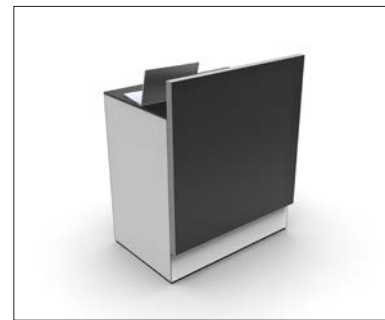
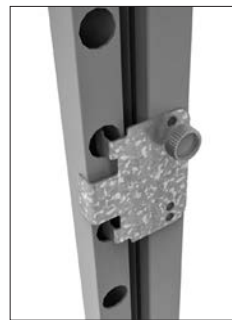

### Universal f31 connector

Using our universal connectors, you can add several elements to the iZi-bar, such as a lightbox or bar element. Fantastic to totally customise your bar.



### iZi-range connector

This connector can be used to connect multiple elements (iZi-bars, iZi-bar elements) in a very simple way.

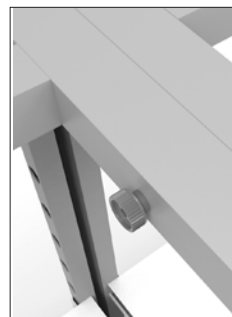

PRODUCT	APPLICATION	ID	DESCRIPTION	DIMENSIONS	FINISH
		420 003 0992	iZi-bar	992 x 620 x 992 MM	RAL 9006 TEC Customisable RAL colour
		420 004 01	iZi-bar Corner	620 x 620 x 992 MM	RAL 9006 TEC Customisable RAL colour
		420 004 02	iZi-bar Elevation	L 992 MM	RAL 9006 TEC Customisable RAL colour
		420 004 03	iZi-bar Corner Elevation	248 X 620 X 248 MM	RAL 9006 TEC Customisable RAL colour
		420 004 04	Barfly module	992 X 620 MM R 0496	RAL 9006 TEC Customisable RAL colour
		420 3703 001	f31 - b62 <sup>®</sup> connector Galva		kit with 4 connectors
		420 3703 002	f31 - b42 connector Galva		kit with 4 connectors
		420 3703 003	f31 Universele connector Galva		kit with 4 connectors
		420 7000 001	iZi-range connector set		kit with 4 connectors
		420 308 001 01	HPL panel 10MM for iZi-bar		White mat
		420 308 001 02	HPL panel 10MM for iZi-bar		Black mat
		420 308 001 03	HPL panel 10MM for iZi-bar corner		White mat
		420 308 001 04	HPL panel 10MM for iZi-bar corner		Black mat

# iZi-tables

## Minimalist look and easy to personalise

Apart from the iZi-bar, beMatrix also offers a range of **iZi-tables**: **ready-made tables or columns that can be covered with all kinds of infills** to match the set-up or function of the stand.

### iZi-wall table

**DIMENSIONS:** 620 X 620 X 1054 MM

**STANDARD FINISH:** RAL 9006 TEC

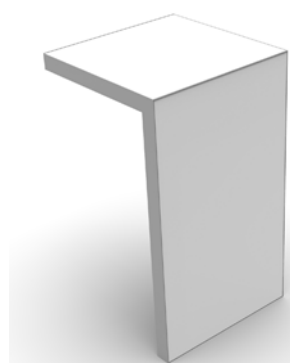

### iZi-high table

**DIMENSIONS:** 1054 X 620 X 1488 MM

**STANDARD FINISH:** RAL 9006 TEC

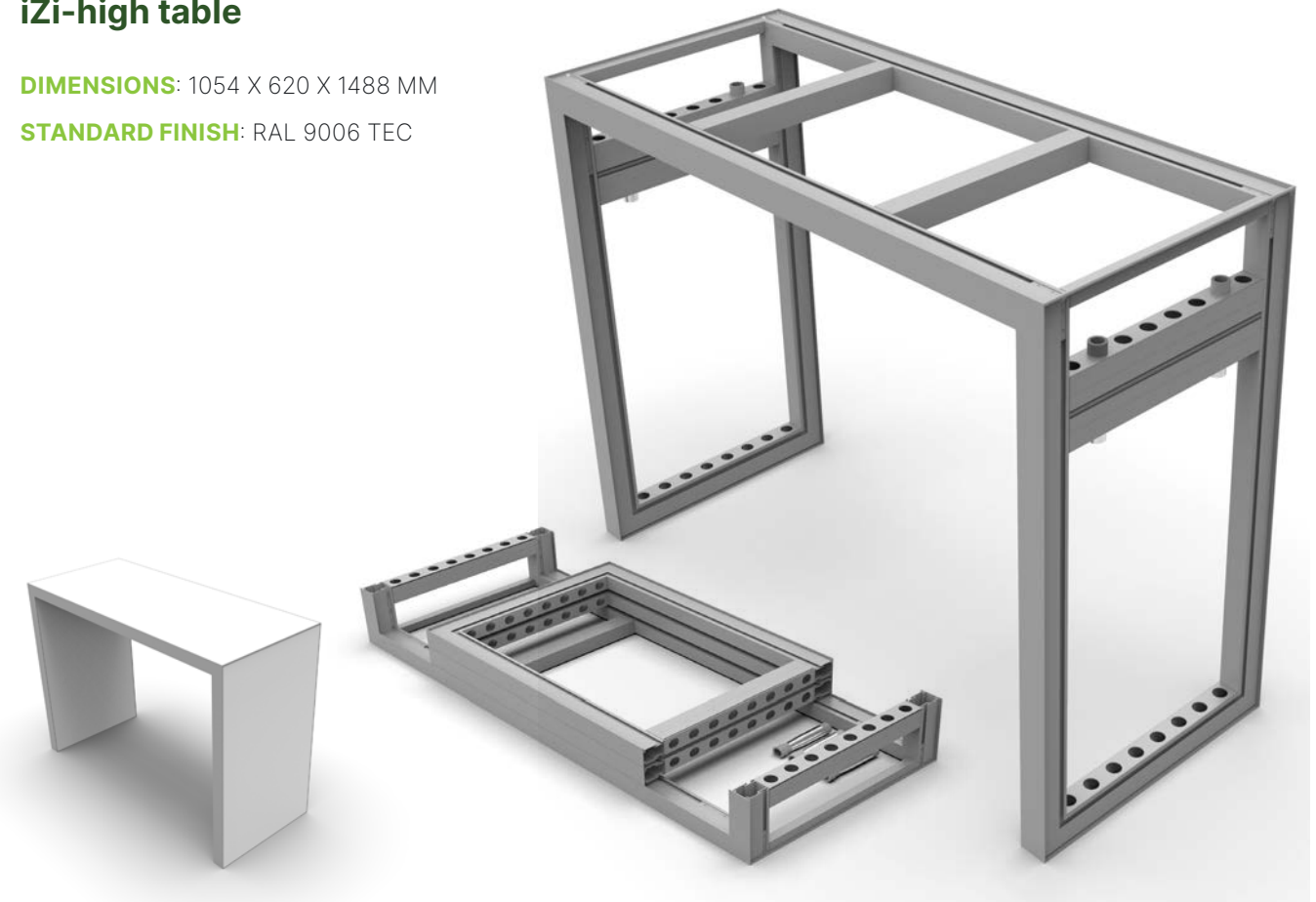

### iZi-column







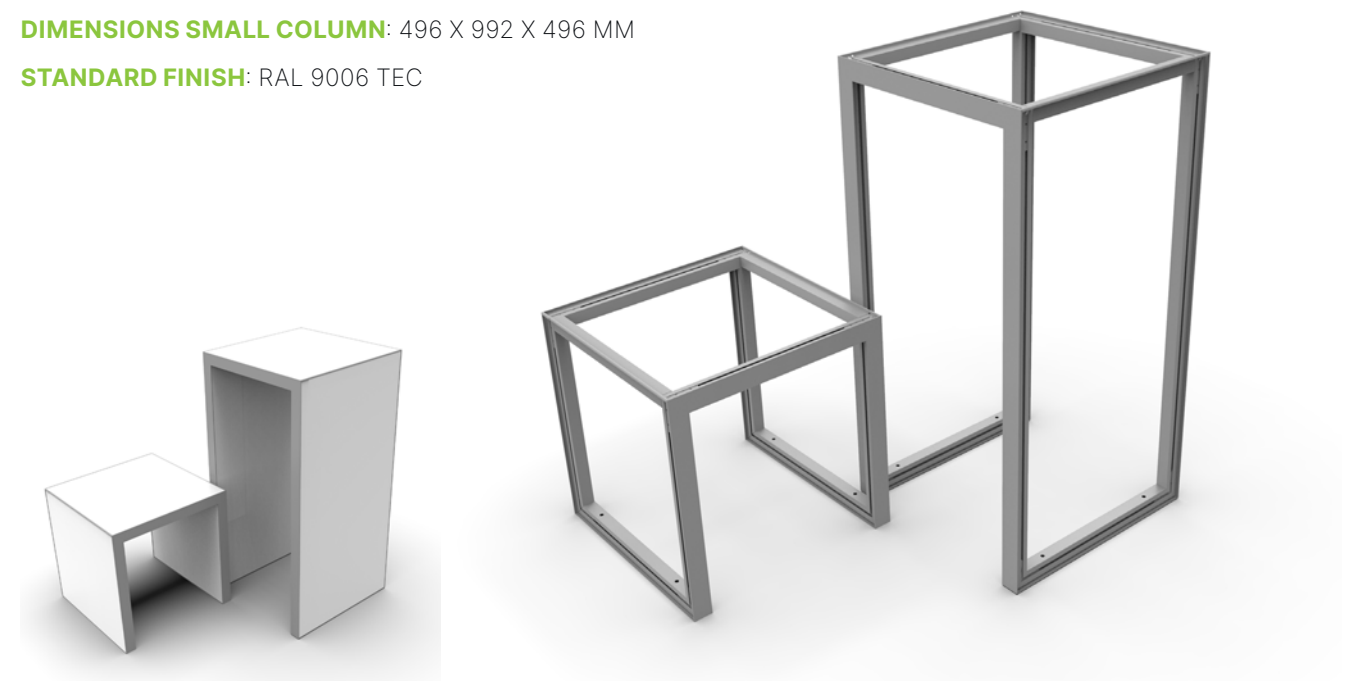

**DIMENSIONS SMALL COLUMN:** 496 X 496 X 496 MM

**DIMENSIONS SMALL COLUMN:** 496 X 992 X 496 MM

**STANDARD FINISH:** RAL 9006 TEC





PRODUCT	APPLICATION	ID	DESCRIPTION	DIMENSIONS	FINISH
		422 001 0620	iZi-wall table	620 x 620 x 1054 MM	RAL 9006 TEC Customisable RAL colour
		422 002 1984	iZi-high table	1054 x 620 x 1488 MM	RAL 9006 TEC Customisable RAL colour
		423 001 01	iZi-column Small	496 x 496 x 496 MM	RAL 9006 TEC Customisable RAL colour
		423 001 02	iZi-column Large	496 X 992 X 496 MM	RAL 9006 TEC Customisable RAL colour

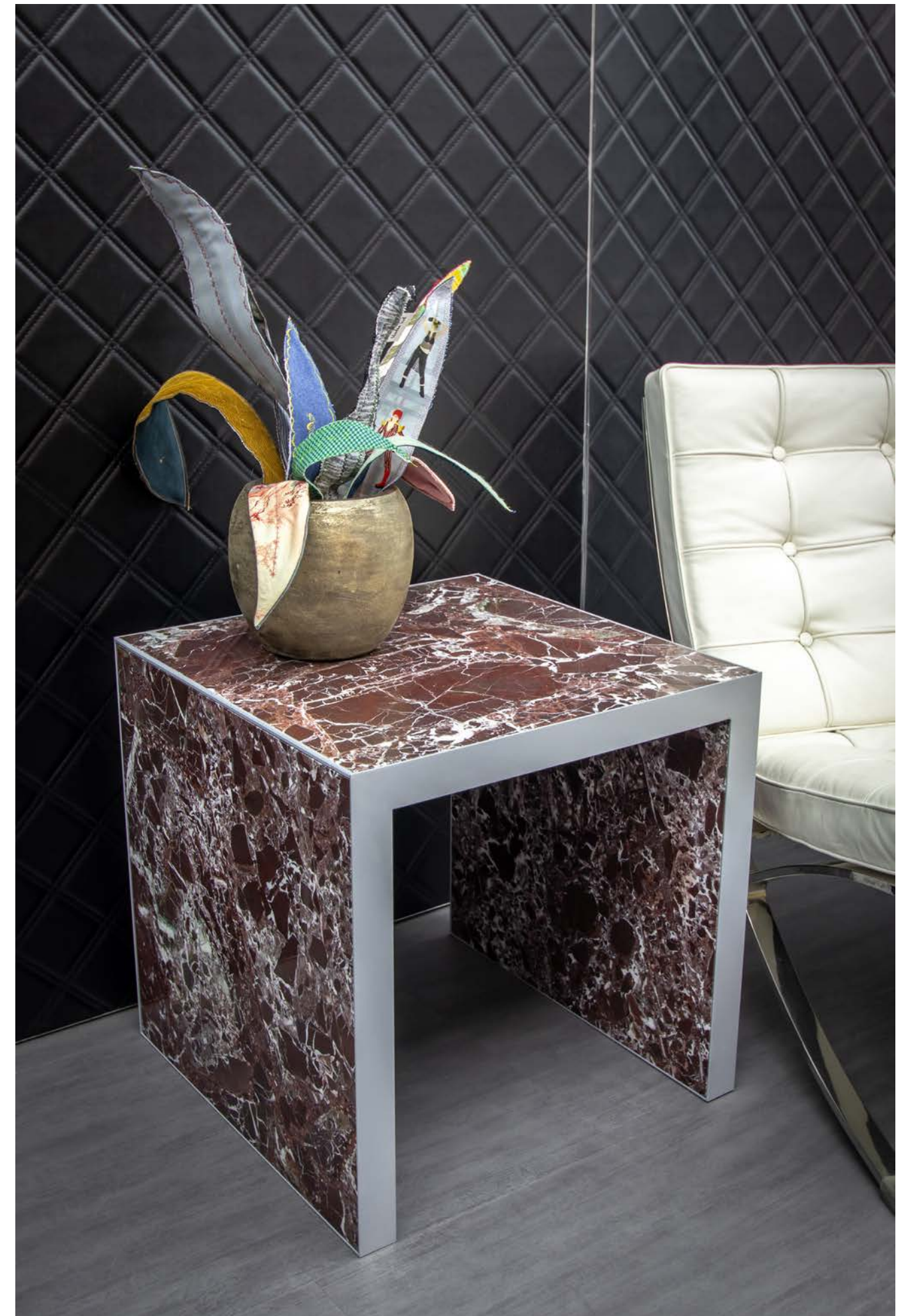





# CO2 Displays



# iZi-tablet holder

## Timeless display

Not only does the **iZi-tablet holder** stand out because of its **minimalist look, but also thanks to its savvy design** providing space for cables and security accessories. The foam protection that covers the back keeps the iPad in position nicely, for optimal reading. Freestanding or secured to the floor? The iZi-tablet holder immediately adds allure to any stand.

**DIMENSIONS:** 240 X 1155 X 362 MM

**STANDARD FINISH:** RAL 9006 TEC



Foam protection

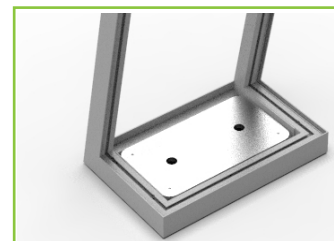

**Tip:** The plate with screw holes at the base of the display makes it perfectly possible to secure the iZi-tablet holder onto a raised floor.



## Infill

Give your iZi-tablet holder any look you like. Is your client going for printed dibond or a plain forex panel? Perfectly possible!

PRODUCT	APPLICATION	ID	DESCRIPTION	DIMENSIONS	FINISH
		425 001 01	iZi-tablet holder	240 x 1155 x 362 MM	RAL 9006 TEC
					Customisable RAL colour

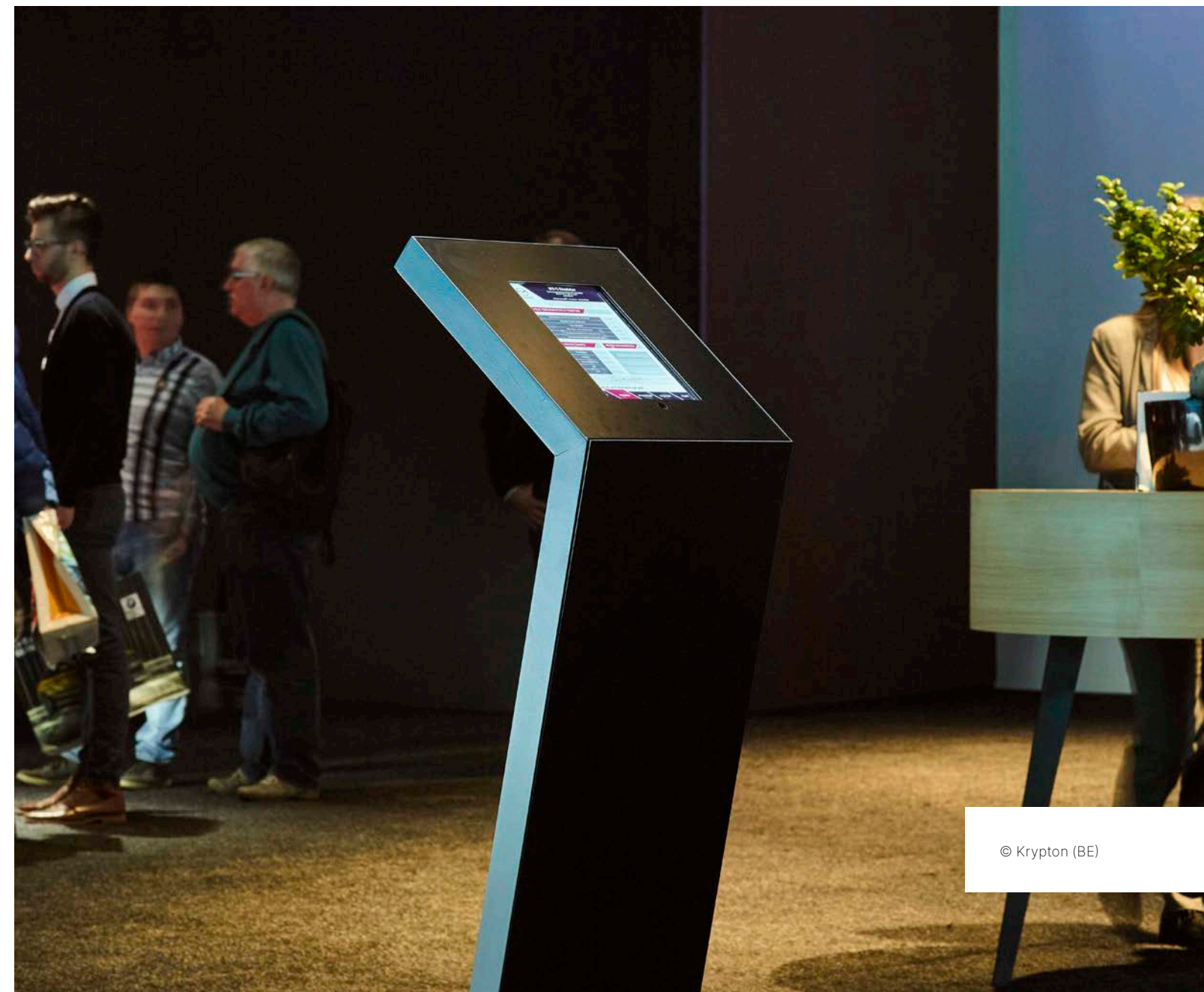





© Deusjevo (BE)



© Quick-Step (BE)

signage



"Winne  
bel  
H  
PATR

Alles begon dit jaar toen Pa  
een nieuwe ploeg voor  
fans. De ploeg deelde zijn  
had de ambitie om een ve  
wereld te worden. Met 2  
Johan Museeuw, Frank  
Bettini, Richard Virenque  
jonge veelbelovende To  
niet lang voordat Quick-St  
dat het menens was. De pl  
tot en met de laatste ma  
februari won Museeuw de C  
dankzij een fantastische ploeg

2005  
HET JAAR VAN TOMS DOORBRAAK

"Tommeke, Tommeke, Tommeke, wat doe je nu?"  
BELGISCHE TV COMMENTATOREN

De klassiekkenners wachtten op een nieuwe  
toernooi. Het was Tom Boonen die als onbetwiste  
heerser moest worden gezien. Hij zette een sensationele  
doortocht neer in de Ronde van Vlaanderen.  
Dit was niet meer de kers op de taart, maar het  
spiegelde wat meer was: later bleek een van de  
beste seizoenen die een renner meemaakte in de  
recente geschiedenis. Nadat hij de voorbije  
Vlaanderen gewonnen had, won Tommeke heel de  
toernooi. De laatste van zijn optreden in de Tour  
vanaf hij een kop stond in het puntklassement  
compleet bij een in een geweldige zegen op het  
Wereldkampioenschap in Madrid. Hij bracht de  
Belgische commentatoren en de hele wereld in  
verzekering.

THE TALKING CLASSIC  
The talking classic was waiting for their time to  
and it was Tom Boonen who came out of Belgium's  
unlabeled king, after having led a successful De  
Ronde of Vlaanderen which wasn't even his  
strongest in the last five years. For the surprise of who  
turned out to be one of the most talented riders in  
his recent career. After coming the night earlier  
"tommeke, tommeke, tommeke, what do you do?"  
The Belgian TV commentators

2007  
GLORIE OP DE CHAMPS-ÉLYSÉES

"Grote kampioenen in je ploeg hebben die voor dezelfde doelen gaan is een luxe probleem."  
PATRICK LEVYSTRIPS

"Having great champions that go for the same objectives is a luxury problem."  
PATRICK LEVYSTRIPS

HET P  
EEN  
2007  
HET P  
EEN  
2007  
HET P  
EEN



# Boxscreen

## Mini

The **Boxscreens** are **solid hanging or standing constructions, which will help your stand grabbing all the attention.** The boxes themselves as well as the textiles allow for easy and efficient (dis)assembly. As with any beMatrix solution, you can be sure of a seamless finish, leaving not one profile on show. The Boxscreen Mini is available on stock, but other dimensions are of course available on request. The corners of the Boxscreen Mini are made out of Zamak, an alloy made out of Zinc, Aluminium, Magnesium and Copper, for a more lightweight structure. The corners of the Mini also come with standard eyebolts in the corners.





**DIMENSIONS:** 992 X 992 X 992 MM

**STANDARD FINISH:** ANO

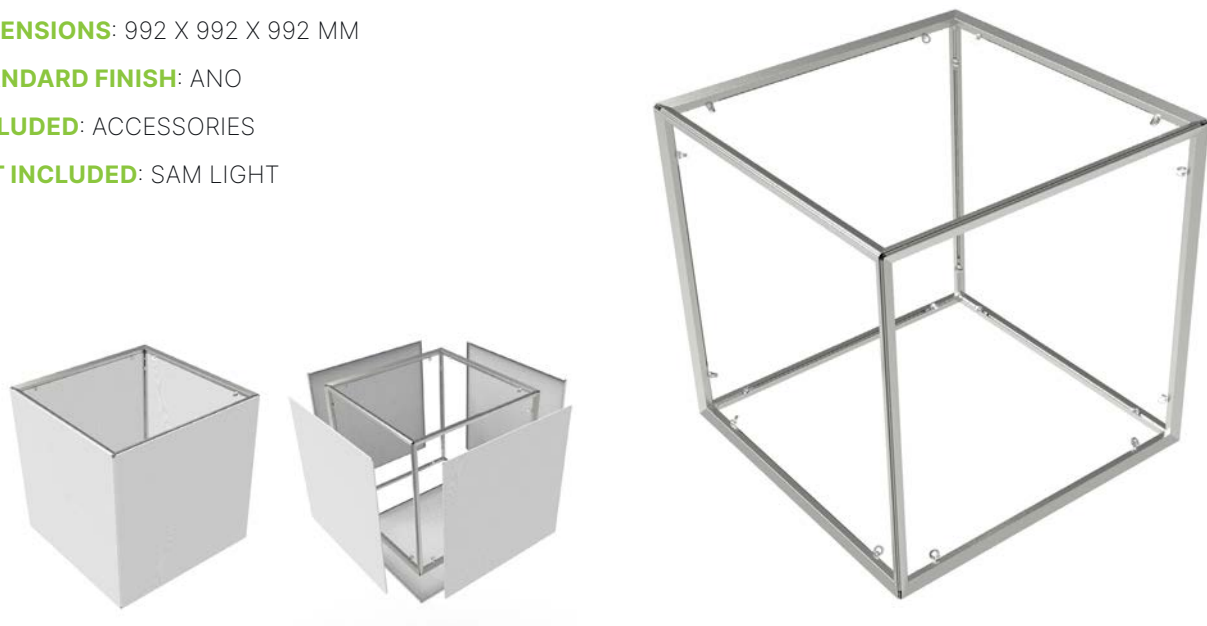
**INCLUDED:** ACCESSORIES

**NOT INCLUDED:** SAM LIGHT



PRODUCT	APPLICATION	ID	DESCRIPTION	DIMENSIONS	FINISH
		430 001 01	Boxscreen Mini	992 x 992 x 992 MM	ANO
		430 001 02	Set 4 X SAM Light warm/cold for Boxscreen Mini (incl. acc)	NOT APPLICABLE	NOT APPLICABLE







# Lightscreen

## Small, medium and large

There is no end to the creative ways in which you can use our lightboxes. From a perfectly aligned lightbox and frame, for a minimal and flawless look, to a unique combination of a number of lightboxes in all shapes and sizes, for a fabulous and eye-catching 3D effect. The sideLED lightboxes are **easy to mount onto the beMatrix frame system**, thanks to the large holes, but you can just as well use them as a free-standing item. The iZi-range lightscreens are available on stock, but we also produce custom-made lightboxes.

PRODUCT	APPLICATION	ID	DESCRIPTION	DIMENSIONS	FINISH
		431 0496 2480	Lightscreen Small	496 x 2480 MM	RAL 9006 TEC Customisable RAL colour
		431 0992 2480	Lightscreen Medium	992 x 2480 MM	RAL 9006 TEC Customisable RAL colour
		431 1984 2480	Lightscreen Large	1984 x 2480 MM	RAL 9006 TEC Customisable RAL colour





BAR  
© Optimum Concept  
& Krypton (BE)



BAR  
© Moodunit (BE)



DESK  
© Choup's (Silver  
Partners) (BE)



DISPLAYS  
© Quick-Step (BE)



IPAD DISPLAY  
© Krypton (BE)



CABINETS  
© G9 Stockholm (SE)

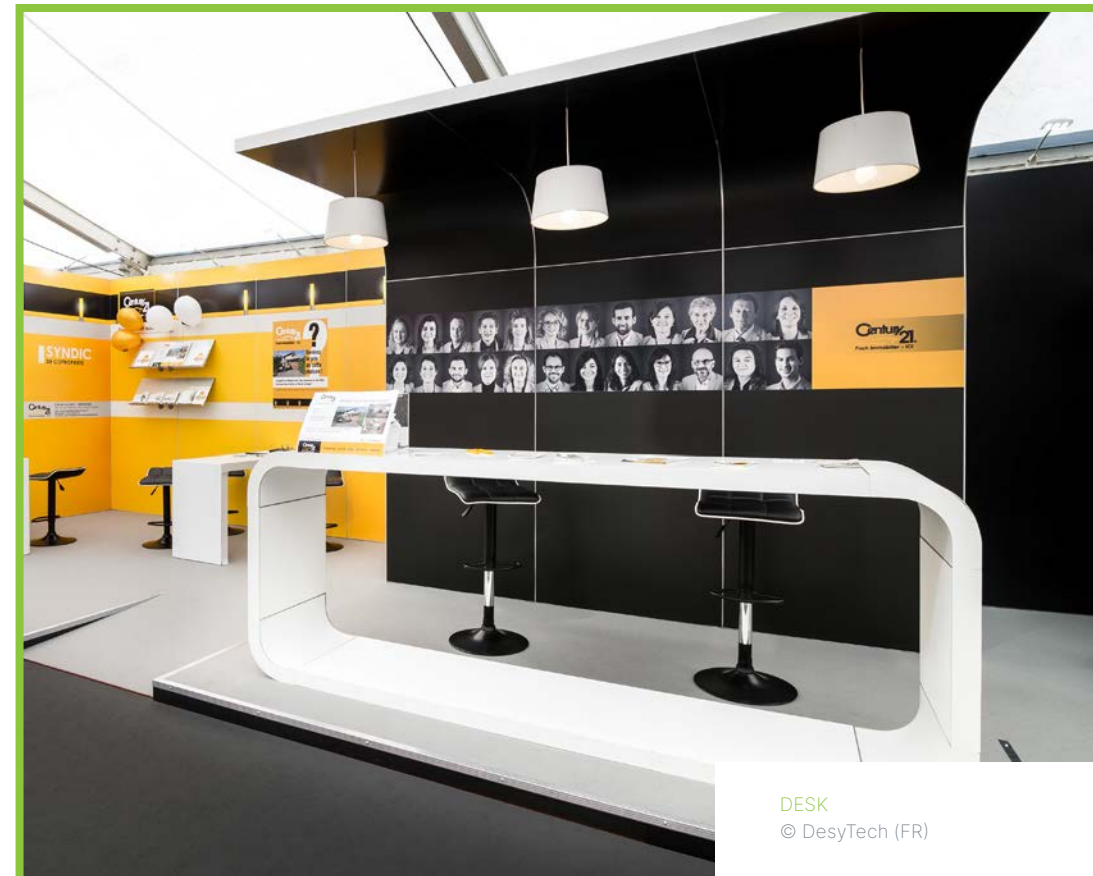

DESK  
© DesyTech (FR)



## The 8 beMatrix principles



### Quality guaranteed

All beMatrix frames are manufactured in-house, so we are in control of every step in the production process. Continuous optimisation and innovation initiatives ensure the system always complies with the market's demands.



### Top finishing

The beMatrix stand building system comes with a large range of tools and accessories to finish your stand exactly the way you envisage it. With the infills, you can even hide the entire frame system so it becomes invisible to the eye. Thanks to our 'seamless' concept, not one seam will be noticeable.

### Freedom to design

A beMatrix stand combines the benefits of a modular system with the possibilities of made-to-measure solutions. Almost any shape, contour and construction is conceivable and can easily be created. One single frame allows you to create all different kinds of stand concepts.



### Lightweight

The aluminium frame system is lightweight, hence very ergonomic and eco-friendly: no need for the stand builder to carry around heavy structures, while the transport weight and CO2 emissions remain low.



### Fast

Assembly and disassembly of the beMatrix system takes hardly any time. Its weight, simplicity and tool free assembly save loads of time, leaving you space to focus on the finishing details of your stand. Isn't that what makes you stand out most at a fair?

### Long life cycle

The system is extremely sturdy, making it endlessly reusable. Wear and tear won't shorten its life cycle, since the frame is not visible to the eye once the entire stand is set up.

### Ecologically sound

Because of its low weight, long life cycle and modular character, the beMatrix frame system is the eco-friendliest system today. Moreover, it is made out of untreated aluminium, so 100% recyclable and reusable without any quality losses.

### International network

The bePartner network brings together real ambassadors of the beMatrix frame system, each with their own expertise: stand building, textile printing, LEDskin®, Double Deck... A creative cross-pollination offering you as our client nothing but benefits.





## bePartners at your service

### **bePartner LEDskin®**

Our LEDskin® bePartners all stock a minimum amount of LEDskin® and have years of expertise in the audiovisual industry. They are more than happy to help you perfectly integrate LEDskin® in your beMatrix stand.

### **bePartner printed textiles**

Printing customised textiles takes real precision. Our bePartners for printed textiles have proven they totally master this specialised skill and guarantee perfect service, time and again.

### **bePartner build**

Our bePartners build have a large stock of frames and accessories, integrate our latest innovations, are able to think outside the box and consider optimal service to be of paramount importance.

### **bePartner LEDskin® content**

Do you already have LEDskin® available, but are you still looking for a partner to help you with content? Our content partners will advise and assist you, from content creation up to and including optimal display quality on your LEDskin® system.

### **bePartner printed panels**

Printing infill panels for our beMatrix frames might seem simple, but this specialised job really has to be executed in a very precise way. Our bePartners for printed panels have already proven they totally master this specialised skill and guarantee excellent service, time and again.



## Global Rental Network: short- and long-term

You want each of your projects to be unique and outstanding with a minimum of investment? You want to grow your business internationally without paying to ship pallets with frames to the other side of Europe unnecessarily? Or how about designing experiences for your clients without being limited by the limits of your stock? In each case, the Global Rental Network is your answer. Our beMatrix Service Centres store a large range of frames, lighting and other beMatrix solutions to support you. We deliver anywhere with all the requisite care and urgency.

We offer two different renting options so you get a beneficial price and, maybe even more interesting, a spread of the costs for your beMatrix project. Renting on short term has a run time of maximum three weeks. The condition to rent on long term is a minimal run time of six months. Both rental plans can also be combined, according to your specific needs. Contact us now for your personal rental solution. Your account manager will help you to decide what the best option is according to the type of products you need.

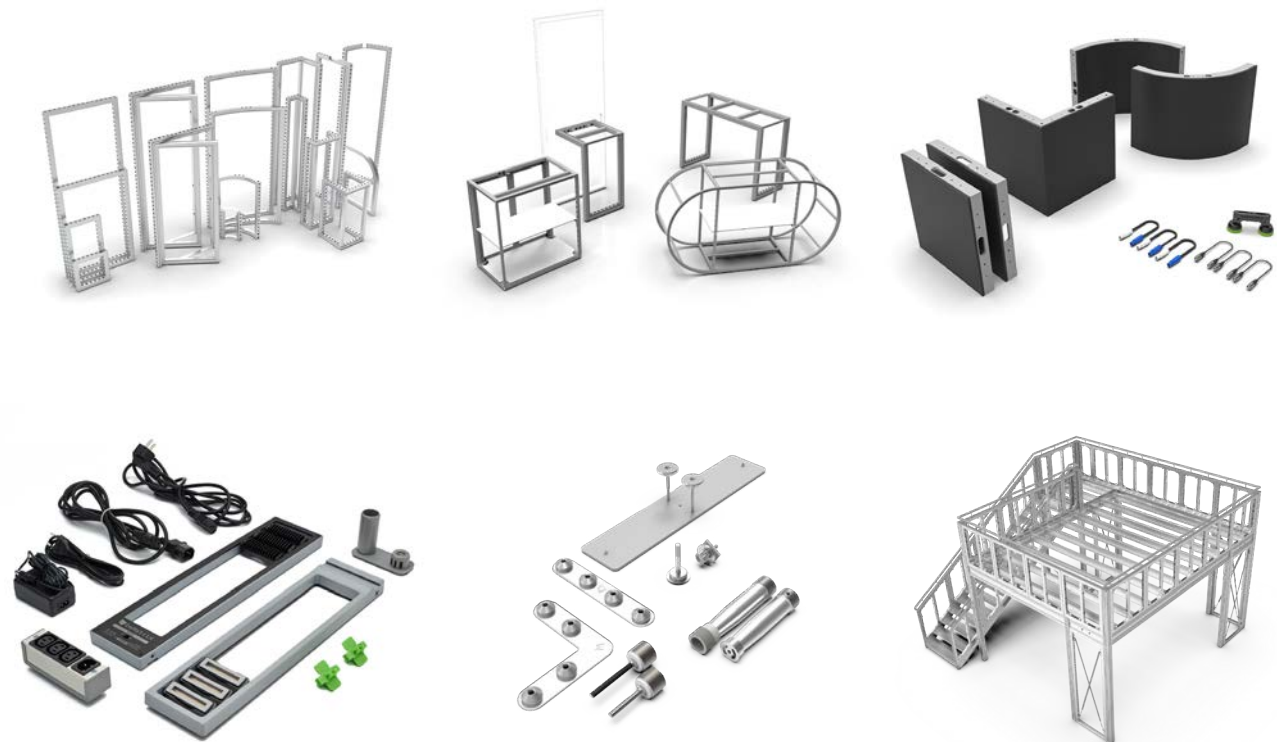





**be strong**  **be stylish**  
**be anything.**

**Come say hi**

HQ Belgium  
Wijnendalestraat 174  
8800 Roeselare

**get in touch**

+32 (0)51 20 07 50  
info@beMatrix.com

**or boost your inspiration**

www.beMatrix.com  
socials @beMatrix  
